



Research Analysts

Charles Brennan CFA

44 20 7883 4705

charles.brennan@credit-suisse.com

William Lunn

44 20 7883 3959

will.lunn@credit-suisse.com

# Blockchain

## CONNECTIONS SERIES

### The Trust Disrupter

**Shared ledger technology and the impact on stocks:** In this report, we reassess our views on the extent to which bitcoin and its underlying technology, blockchain, present a disruptive threat and/or opportunity to global incumbents operating in the payments, capital markets, financial services and media ecosystems. We leverage Credit Suisse's global franchise to deliver the collective cross-sector and cross-border insights of 31 contributing analysts across 5 sectors and 5 key geographies, providing 14 key stock calls.

- **Bitcoin:** We find 13 barriers to mainstream bitcoin adoption presenting a meaningful challenge in aggregate. We think these challenges will need to be overcome before widespread adoption becomes a possibility.
- **Blockchain:** A shared ledger requiring consensus to update, with tamper-evident properties that is economically unfeasible for any single entity to retrospectively alter is a bigger disruptive threat. We find blockchain more easily optimizable to different objectives than bitcoin and think three key properties—disintermediation of trust, immutable record and smart contracts—endow the technology with real advantages to legacy systems. However, we also examine eight key challenges that have the potential to limit blockchain's utility, and therefore slow its adoption.
- **Stocks:** Our conclusions are supportive for payments companies (like Worldpay) and card networks (like Visa). We see the biggest impact in areas like financial services, exchanges and post trade settlement, where T+3 settlement looks ripe for optimization. In particular, we see scope for vertical integration across exchanges, clearing, settlement and registration. The winners and losers from this consolidation are still not clear, but the market appears to be overlooking risks for some exchanges (ASX), and we would argue unfairly pricing the registrars (Equiniti and Computershare) for disappointment.

**Figure 1: The momentum of interest in blockchain has increased**

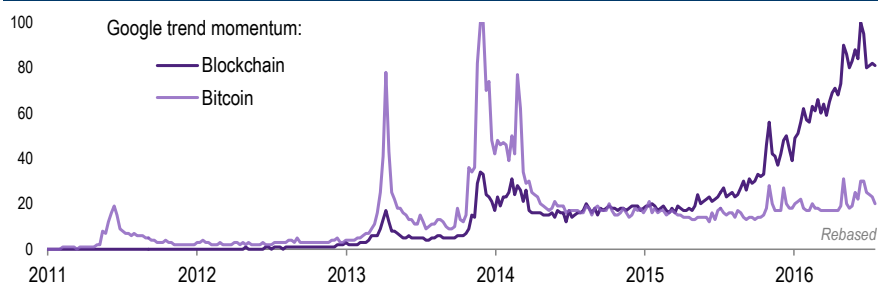

Source: Google Trends Data, Credit Suisse research

**DISCLOSURE APPENDIX AT THE BACK OF THIS REPORT CONTAINS IMPORTANT DISCLOSURES, ANALYST CERTIFICATIONS, LEGAL ENTITY DISCLOSURE AND THE STATUS OF NON-US ANALYSTS.** US Disclosure: Credit Suisse does and seeks to do business with companies covered in its research reports. As a result, investors should be aware that the Firm may have a conflict of interest that could affect the objectivity of this report. Investors should consider this report as only a single factor in making their investment decision.

# Table of contents

<b>Executive Summary</b>	<b>7</b>
<b>The Blockchain Protocol</b>	<b>19</b>
Understanding Blockchain through Bitcoin .....	19
13 Blocks to Bitcoin Dominance .....	33
<b>Separating Blockchain from Bitcoin</b>	<b>38</b>
Understanding Shared Ledgers – Levels and Layers .....	40
Challenges Facing Blockchain .....	44
<b>Impact on the Real Economy</b>	<b>50</b>
<b>Payments</b>	<b>54</b>
Analyst View: Global Payments .....	61
Worldpay (WPG.L) .....	63
Fiserv, Inc. (FISV).....	64
DH Corporation (DH).....	65
<b>Exchanges, Registrars and Custodians</b>	<b>66</b>
Analyst View: Global Exchanges.....	73
ASX (ASX.AX / ASX AU).....	77
London Stock Exchange (LSE.L) .....	83
Japan Exchange Group (8697) .....	84
NASDAQ Group Inc. (NDAQ).....	86
Analyst View: UK Business Process Outsourcing service providers .....	88
Equiniti (EQN.L).....	95
Capita (CPI.L).....	96
Computershare (CPU.AX / CPU AU) .....	97
Analyst View: Global Custodians .....	103
<b>Financial Services</b>	<b>104</b>
Analyst View: Financial Services.....	108
Goldman Sachs Group, Inc. (GS) .....	113
JPMorgan Chase & Co.....	114
Experian .....	115
Santander (SAN.MC).....	116
<b>Media</b>	<b>117</b>
Analyst View: Global Media Team .....	120

Figure 2: Contributing analysts

**31** Analysts across **5** Sectors and **5** Geographies, providing **14** Stock calls

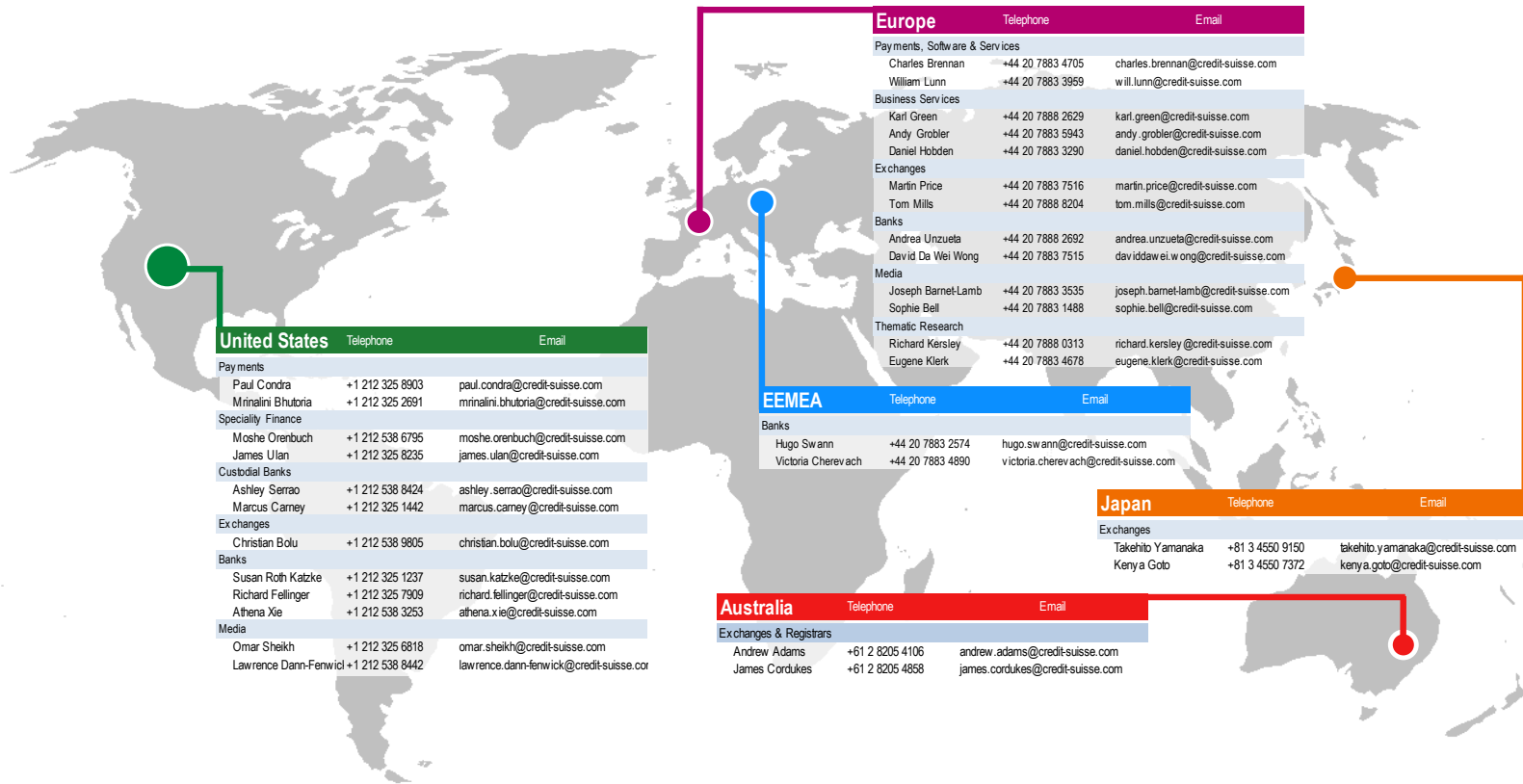

Source: Credit Suisse research

## Overview

### Answering investors with expert views

This report has been written in direct response to the increasing level of investor questions we have received surrounding blockchain technology and its potential to disrupt traditional industries. While many of these questions have been focused on the payments industry, blockchain is a technology that is relevant to a wide range of sectors. As a result, this report pulls together the collective insights from 31 analysts in 5 sectors in 5 regions around the world.

In turn, these analyst views draw upon a wide variety of expert opinions; our analysts have met with thought leaders at Consult Hyperion and technology experts at companies closer to home like Worldpay and Equiniti. This report also draws on discussions with experts from as far afield as Computershare in Australia and the Japan Exchange Group. As a result, this is a comprehensive overview of the global blockchain landscape.

### Opportunities and challenges

For the more technically minded, this report details some of the underlying concepts and technology behind blockchain. This deep dive explains the benefits of a 'shared ledger' and how this can structurally disintermediate trusted third parties. However, the report also explains some of the fundamental cryptography and consensus forming characteristics of a blockchain. These fundamentals expose some of the challenges blockchain faces in balancing security and anonymity with the constraints of scalability and cost. Consequently, while the technology is undeniably powerful and will have a material impact, blockchain is not necessarily disruptive in all cases; in many industries, the technology is a solution searching for a problem.

### Bitcoin appears limited but blockchain is key

Bitcoin, a decentralized peer-to-peer payment network, is one application of blockchain and explains why much of our investor interest has focused on payments. However, we believe there are 13 barriers to mainstream bitcoin adoption and we are convinced it will remain a niche payment network. In contrast, the underlying blockchain technology, a distributed database that holds a secure and immutable record of past transactions, is the key differentiator that has the ability to disrupt.

### Sector relevance

This report takes the potential of blockchain and overlays it with sector context. Our broadest conclusion is that blockchain is less relevant in sectors where there has already been significant investment and innovation. For instance, consumer payments and pre-trade execution already takes place in milliseconds; it is hard to see how blockchain could materially improve this efficiency. However, in sectors where there is more friction, blockchain has the potential to materially disrupt the landscape.

This report is supportive for payments companies (like Worldpay) and card networks (like Visa), and is neutral for Media. We see the biggest impact in areas like financial services, exchanges and post trade settlement, where T+3 settlement looks ripe for optimization. In particular, we see scope for vertical integration across exchanges, clearing, settlement and registration. The winners and losers from this consolidation are still not clear, but the market appears to be overlooking risks for exchanges (ASX) and, we would argue, unfairly pricing the registrars (Equiniti and Computershare) for disappointment.

With the ASX due to report the results of its blockchain trials in 2017, we believe this will be a key debate for investors over the next 18 months.

## Stock-specific implications

### Worldpay (Outperform)

#### Risks are misplaced

We spoke to a number of investors who are concerned about medium-term disruption to the payments landscape. However, our analysis shows there is little risk from blockchain. Importantly, we believe the market growth dynamics and structure are robust and hence we continue to emphasise our Outperform rating. Our key conclusions are that; 1) bitcoin is likely to remain a niche payment network and unlikely to gain mainstream adoption, and 2) we see little scope for blockchain technology to disrupt the back-end architecture given that card acceptance already takes place instantly and card schemes provide invaluable dispute management which is difficult for a new technology to disintermediate.

### Capita (Neutral) and Equiniti (Outperform)

#### More opportunity than risk

We see medium-term scope for blockchain technology to change the structure of capital markets, speeding up settlement times and consolidating disparate processes across clearing, settlement and registration. This opens the door to shifting revenue shares across the value chain.

While we acknowledge scope for the landscape to change, we believe that the registrars who have deep, long standing relationships with end customers are well positioned to try and take advantage of this vertical integration and expand into brand new markets, eg custodian services. As a result, we think fears of disintermediation are overplayed.

On the other hand, we think blockchain could give rise to new opportunities. In the case of Equiniti, there is scope to use blockchain to drive down payment costs. In the case of Capita, there could be material opportunities in the public sector as the UK government explores options for distributed ledger technology in areas such as the creation of a single record of ID, a DLT-based land registry, and the issuance of passports and drivers' licences. As a result, we think blockchain is a medium term net positive for Capita and Equinity.











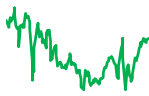
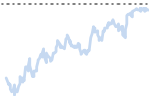

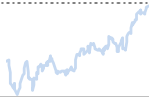
### Computershare (Outperform) and ASX (Neutral)

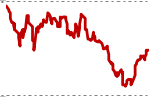
#### On top, down under

Australia appears to be leading global blockchain innovation, and the Australian Stock Exchange is currently partnering with Digital Asset to develop solutions based on distributed ledger technology. The ASX estimates that blockchain could lower the cost of the Australian equity markets through lower costs and a reduction in risk. This potentially reduces the revenue opportunity for players across the value chain, although new technology will also create new opportunities. Against this backdrop, we believe ASX (Neutral) already reflects a positive scenario where revenues see a small incremental benefit. However, there is little factored into the valuation in the event that clearing revenues (7% of the total) come under pressure.

Our preferred play on the opportunity is Computershare (Outperform). The shares currently trade on a 40% discount to the market, which seems to fully discount a bear case scenario where earnings could fall 10%. However, there are potential positives, such as new market expansion into the US. If successful, this could add c10% to earnings. We think this upside scenario is misunderstood and undervalued.

**Figure 3: Key stock ratings**

Company Name	Ticker	Covering Analyst	Market cap, \$m	Rating	Current Price	Target Price	Change to TP, %	Performance, year-to-date
Worldpay	WPG	Charles Brennan	7,796	OP	2.96 GBp	3.00 GBp	1.4%	
Fiserv, Inc.	FISV	Paul Condra	24,343	N	109.49 USD	101 USD	-7.8%	
DH Corporation	DH	Paul Condra	2,625	OP	32.25 CAD	40.00 CAD	24.0%	
ASX	ASX	Andrew Adams	7,284	N	49.94 AUD	45.00 AUD	-9.9%	
London Stock Exchange	LSE	Martin Price	12,671	OP	27.46 GBp	29.00 GBp	5.6%	
Japan Exchange Group	8697	Takehito Yamanaka	7,712	UP	1,438.00 JPY	995 JPY	-30.8%	
NASDAQ Group Inc.	NDAQ	Ashley Serrao	11,681	OP	71.00 USD	72.00 USD	1.4%	
Equiniti	EQN	Karl Green	672	OP	1.70 GBp	2.10 GBp	23.5%	
Capita	CPI	Karl Green	8,286	N	9.43 GBp	9.00 GBp	-4.6%	
Computershare	CPU	Andrew Adams	3,639	OP	8.84 AUD	10.00 AUD	13.1%	
Goldman Sachs Group, Inc.	GS	Christian Bolu	64,785	OP	155.96 USD	180 USD	15.4%	
JPMorgan Chase & Co.	JPM	Susan Roth Katzke	232,818	OP	63.58 USD	75.00 USD	18.0%	
Experian	EXPN	Andrew Grobler	18,332	OP	14.53 GBp	15.05 GBp	3.6%	
Santander	SAN	Andrea Unzueta	56,521	N	3.51 EUR	3.80 EUR	8.3%	

Source: Company data, Credit Suisse estimates, priced 2 Aug 2016

## Executive summary

*"On the streets of Davos this year there are only three discussions being had. One: robots are going to take over our jobs. Two: blockchain is amazeballs and three: FinTech is like blockchain amazeballs, but with even more possibilities to control and mould the behaviours of the common man."*

- FT, January 20<sup>th</sup> 2016

### Disrupting trust-based transacting

The blockchain is increasingly recognized as the most significant technical innovation of bitcoin. Google search data (see Figure 5) reflects this trend and we have noted a rapid recent increase in our clients' interest in blockchain's disruptive potential, particularly its impact on the payments space. Most simply, the blockchain protocol is a cryptographically secure system of messaging and recording in a shared database. Working in tandem, these systems enable the secure record, verification and confirmation of transactions without the need for a central counterparty to administer the system.

Ordinarily, organizations and individuals without commitment to each other lack the mutual trust necessary to transact. We think of this through an adapted prisoner's dilemma in Figure 4. The Nash equilibrium (best possible response regardless of others' actions) is to cheat. This holds in an iterated version where the game is played multiple times, as inductive reasoning suggests that if one 'may as well' cheat on the last turn, then rational players will cheat every time.

**Figure 4: The Nash equilibrium for an adapted prisoner's dilemma is to cheat in transacting**

	Transact	Cheat
Transact	10, 10	-10, 20
Cheat	20, -10	0, 0

Source: Credit Suisse research

**Figure 5: The momentum of interest in blockchain has greatly increased in recent months**

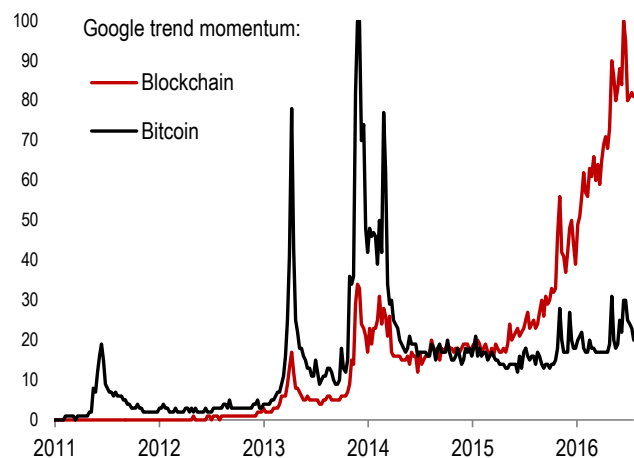

Source: Google Trends, Credit Suisse research

To transact, you must trust that the:

- Value transfer commitment between parties will be met;
- Other party has ownership over the value they agreed to transfer;
- The value transferred is legitimate.

As rational actors in a transaction cheat (see Figure 4), we have historically mitigated this fundamental trust issue by transacting through neutral central authorities in which both parties have confidence. Through neutrality, maintenance of centralized ledgers, risk

management, processes such as novation, the central mediator can ensure transacting parties a) own what they have agreed to exchange, b) ensure the transaction occurs, and c) ensure the veracity of the transferred value.

Think of an art broker with links to a wide network of collectors. One has a Cézanne for sale, another wants a Cézanne. The dealer's specialization in Post-Impressionist art and research of the particular paintings provenance enables the dealer to confirm it is owned legitimately by the seller, and is authentic. The broker then buys it from the seller, and sells it on to the buyer, the spread is his commission. Thus the trusted third party art broker enables two collectors who lack a relationship to transact value without trust.

Using a central authority to ensure transaction validity represents a single point of failure – the broker could lie - and requires transaction costs – the broker takes commission. Transaction architectures built on blockchain protocols (like bitcoin) can disintermediate the process of value exchange, the trusted third party is supplanted by the implementation of a shared public database, alteration of which requires consensus of all participants.

Blockchain is a trust machine. Cryptography is used to maintain a peer-to-peer distributed, time-stamped and immutable consensus ledger of all past transactions. Each transaction is similar to a ledger line item, which is then aggregated with others into a block of transactions - similar to a page of a ledger – we are left with a chain of blocks, each connected to the last. As each block of transactions needs to be agreed by consensus to be added to the chain, transaction records cannot be forged, censored or reversed once a block is added, and transacting without trust becomes possible.

**Figure 6: The three sins of a centralized ledger**

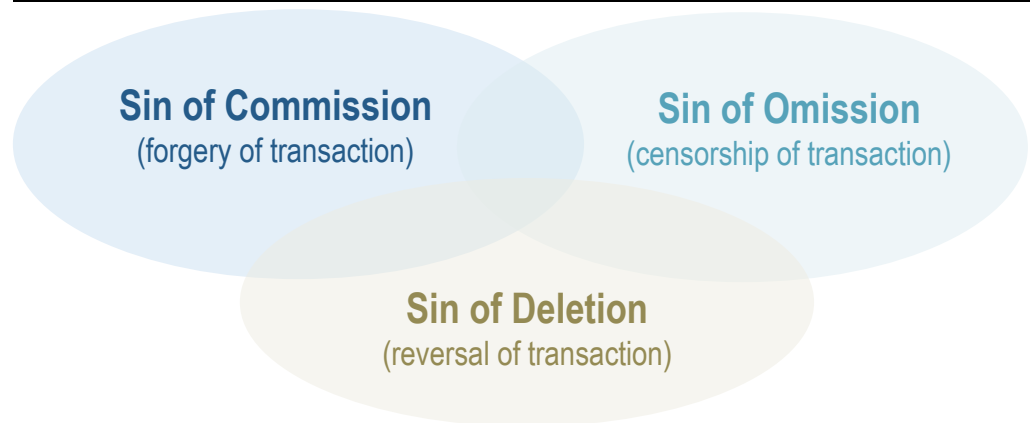

Source: Credit Suisse research

Were art ownership and provenance stored on a blockchain (as Deloitte's ArtTracktive proof of concept shows is possible, see press release [here](#)), the Cézanne collectors could transact with each other without the broker. The process becomes simpler, less exposed to the three sins of a centralized ledger (see Figure 6), and cheaper.

Bitcoin is the most developed system predicated on blockchain. We explain in some detail the lifecycle of a bitcoin transaction in order to more intimately understand blockchain from a slightly more technical standpoint. We focus on:

- **The cryptography:** Hash functions and digital signatures
- **Building blockchain:** Transactions, Merkle trees, Proof of work
- **The economics:** Miners incentives and economics



Many have been understandably excited by the potential of cryptocurrencies to be a P2P currency with the potential to supplant fiat – thereby removing central banks and creating a 'bankless' environment.

We interrogate this potential, ultimately examining 13 barriers to mainstream bitcoin adoption which, while not insurmountable in isolation, we think present a meaningful impediment in aggregate. In particular, we find the large opaque cost of maintaining the network, internal developer conflict, scalability issues and increasing centralization present immediate and persistent challenges which must be overcome before widespread adoption becomes a possibility. Similar to HTTP - the foundation stone of the internet, blockchain is a protocol, and bitcoin the application for a distributed value exchange system.

Therefore, we find ourselves in agreement with the increasingly consensus view that it is blockchain, and not bitcoin, which presents the more credible disruptive threat/opportunity.

**Figure 7: Traditionally, a 'centralized ledger' approach solves the transaction trust issue by tracking the movement and ownership of value**

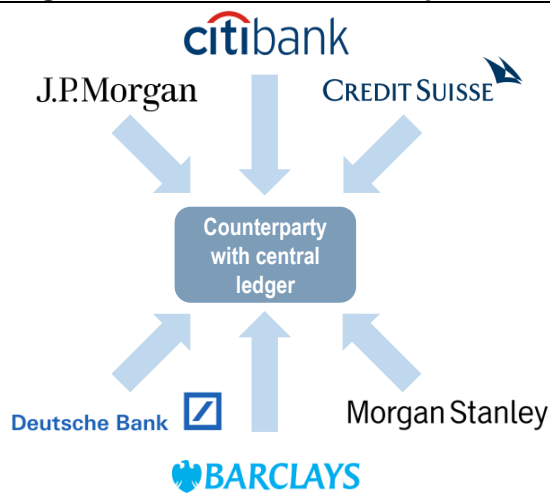

Source: Credit Suisse research

**Figure 8: A secure distributed ledger removes the counterparty as the transaction record is universally visible and immutable**

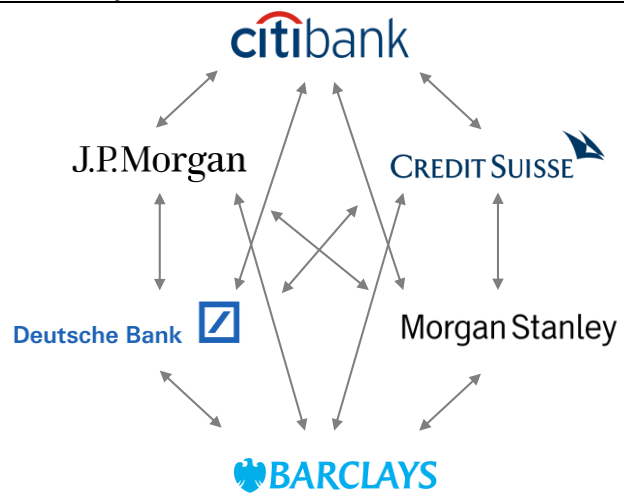

Source: Credit Suisse research

**Bottom line: Bitcoin bad, Blockchain better...**

Bitcoin is a particular sort of blockchain implementation: anyone can see transaction record (blockchain), and anyone can take part in verifying transactions (mining). In our analysis, some of the issues we highlight with bitcoin can be circumnavigated through the implementation of other types of ledger; these 'levels' govern the read/write permissions:

- **Traditional ledger:** Centralized, only the owner can read and write the ledger, record is not immutable. Must be reconciled with other ledgers to settle transactions.
- **Permissioned Private Ledger:** Decentralised, only permitted entities may read and write the ledger.
- **Permissioned Public Ledger:** Decentralised, only permitted entities may write the ledger, but anyone may view the ledgers contents.
- **Unpermissioned Public Ledger:** Distributed, anyone can read and write the ledger, as long they meet certain criteria and follow certain rules.

In addition to the ledger permission levels, layers govern the functionality:

- **Control layer:** Denotes whether the chain is permissioned, who has control over read or writing of the ledger.
- **Communication, Consensus and Content layers:** How instructions are propagated through the network, how transaction validity is agreed and what is transacted.
- **Contract layer:** To what extent transactions may be animated to self-execute based on pre-defined criteria.

Each of these layers and levels can be flexed to optimize a blockchain architecture to achieve different objectives. For example, using an on-chain token like bitcoin may be useful for cross-border payments, but sometimes the value naturally exists off-chain. For example, our Cézanne collectors painting, here the 'content' would need to be an on-chain representation of off-chain ownership.

We think the flexibility of different layer/level blockchain combinations offers enhanced utility relative to the rigidity of bitcoins Unpermissioned Public ledger.

**Figure 9: Ledger levels (govern read/write permissions) and ledger layers (govern functionality)**

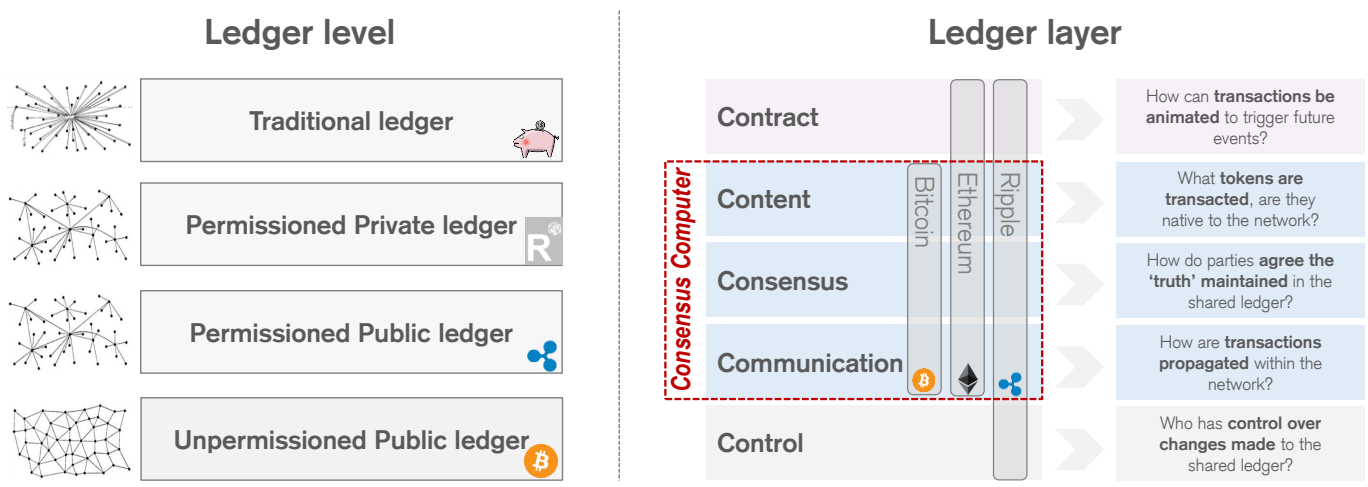

Source: Credit Suisse research based on data from Consult Hyperion and On Distributed Communications Networks by Paul Baran, 1962

We distill the disruptive benefits of this blockchain into three simple points:

- **Immutability of record.** All participants share and consensually update the record. This translucent, immutable and permanent record imparts confidence in the provenance of value being transacted and enhances fraud detection.
- **Disintermediation of trust.** Less reliance on trusted third parties. Third party risk is reduced or eliminated as trust is distributed over the network, rather than centralised in one potentially fallible 'single point of failure'.
- **Smart contracts.** Self-executing commitments, fulfilment of which can be trusted. Obligations codified by smart contracts are easily replicable, and have the benefit of security, verifiability, translucency and immutability of the blockchain.

In addition to the above, we like the security and efficiency properties that perhaps can be afforded to blockchain-based systems:

- **Quick to update:** Processing and transaction times are reduced with many incentivised actors (consider the Wikipedia example).
- **'Permanent uptime':** Blockchain architecture's reliance on distribution means that permanent unassailable up-time is achievable.
- **Borderless:** Being network-based and without centralisation, blockchain architectures are unimpeded by borders.
- **Incorruptible and more DoS resistant:** The multi-redundant nature of peer-to-peer shared ledgers means even if several nodes are attacked, the network can be supported by others. Sharing multiple copies which are synchronously updated acts as a constant back-up system for the entire ledger.

### Challenging the hype...

The buzz surrounding blockchain is comparable to that surrounding the internet in the late 1980s – some go as far as to suggest that blockchain has the potential to reimagine and reinvent key institutions – for example, the corporation. We are less sanguine, and note eight key challenges that have the potential to limit the utility, and therefore reduce adoption, of blockchain systems.

1. **Security vs Cost trade off:** The security of the bitcoin blockchain is ensured by syntactic rules and computational barriers to mining. Permissioned architectures are cheaper to run, but as we increase our trust in permissioned authors, we lose the distribution which is a guarantee of ledger integrity
2. **Do you actually need blockchain? 'If it ain't broke, don't fix it,'** for a blockchain to be relevant you must: (1) require a database, (2) need shared write access, (3) have unknown writers whose interests are not unified, and (4) not trust a third party to maintain the integrity of the data.
3. **Critical mass is essential:** Blockchain-based solutions intrinsically rely upon multiple users, particularly at the authoring level. We see clear threats to achieving critical mass (1) fragmentation of platforms, and (2) institutional and social inertia to transition to and/or agree on a platform.
4. **What you get out is only as good as what you put in...** In reality the 'truth level' of on-chain information is only as good as barriers employed to (1) ensure the quality of data being added is high, and (2) ensure the quality of node permissioned to add to the chain is high.
5. **More entry points make a blockchain system more hackable...** The hackable 'surface area' of a distributed network increases with each node added.
6. **You have to see it to believe it...** Although identity can be encrypted relatively easily on a blockchain, transaction data are not for the simple reason that nodes have to see it to verify it. This may be an issue for those concerned about data privacy.
7. **Identity problems?** On-chain asset ownership by virtue of private key knowledge essentially makes all on-chain assets bearer instruments. The issue with bearer instruments is you can lose them; cash being the most salient example. A better solution to reconciling on and off-chain identity appears necessary.
8. **A forked road, the lesson of the DAO attack...** The DAO attack exposed flaws in smart contracts on Ethereum which should act as a reminder that nascent code is susceptible to bugs before it is truly tire-kicked, and even then, complete surety is never guaranteed. The 'hard fork' undertaken by the Ethereum community also shows that blockchains are only immutable when consensus wants them to be.

### What does blockchain mean for the real economy?

Most obviously impacted are (1) industries in the business of selling trust, and (2) industries which currently experience great friction. We think about the way these sectors will be impacted in three ways:

- **Opportunities:** Cost removal, efficiency enhancement, novel revenue streams.
- **Traps:** Disintermediate incumbents.
- **Growth:** Where as yet unimagined potential arises from blockchain applications

As to timeframe, we look to the World Economic Forum whose survey of over 800 executives saw 58% of respondents expect 10% of GDP to be stored on the blockchain, before 2025, 73% of those surveyed expect tax to be first collected on-chain pre-2025.

The potential for disintermediation has not been ignored by the market. Karl Green, our business service processors analyst, believes share registrar Equiniti's absolute P/E multiple (and at a material discount to the wider sector) is in some part due to investors' growing awareness of the disruptive potential of blockchain across a wide range of financial services functions.

**Figure 10: Blockchain thought leaders believe blockchain will most impact Financial Services...**

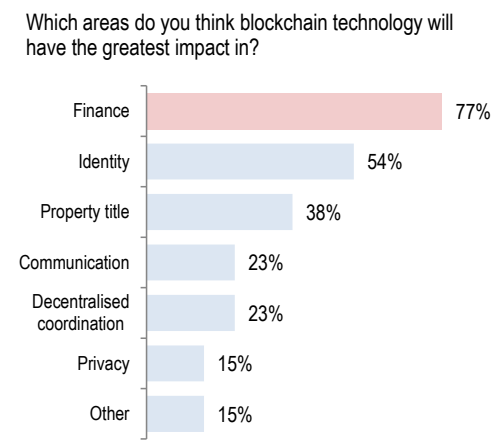

Source: Bitcoin and Blockchain Thought Leaders Annual Survey, Credit Suisse research

**Figure 11: ... within Financial Services, Payments and Capital markets appear most disruptive**

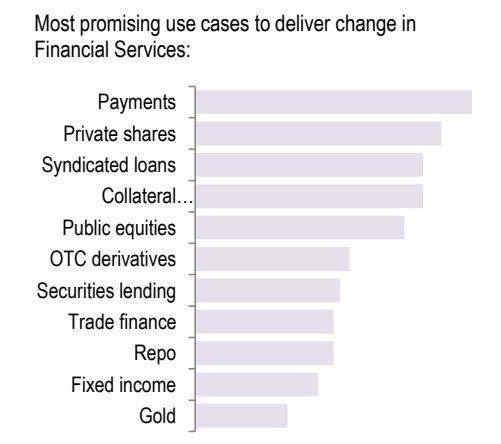

Source: Greenwich Associates 2016 Blockchain Adoption Study, Credit Suisse research

We interrogate the potential of blockchain in relevant industries:

- **Payments:** Merchant Acquirers, Card Issuers, and Financial Payments Processors,
- **Capital Markets:** Custodians, Exchanges and Registrars,
- **Financial Services:** Retail Banks, Investment Banks and Credit Bureaus
- **Media:** Music: Ad-funded TV, Pay TV, Digital Video and Publishing

We have leveraged Credit Suisse's global franchise to deliver the collective cross-sector and cross-border insights of 30 analysts across 5 sectors and 5 key geographies. Our analysts' views draw on a wide variety of expert opinions, having met with thought leaders at Consult Hyperion and technology experts at companies closer to home like Worldpay and Equiniti. This report also draws on discussions with experts from as far afield as Computershare in Australia and the Japan Exchange Group. As a result, this is a comprehensive overview of the global blockchain landscape.

# Payments

## Use case

In consumer payments, we speak to a number of investors who believe the sheer scale of the industry and the complicated four-party structures make it ripe for medium term disruption. We see two possible scenarios for blockchain technology to disrupt payments:

1. Bitcoin (or another cryptocurrency) gains critical mass as a payment method
2. Blockchain technology is used as a base to replace the current payment rails – disrupting the incumbent four-party card system.

## Analyst view

We judge the obstacles to widespread bitcoin adoption as insurmountable in aggregate. Additionally, although we recognize the benefits of a permissioned public ledger – it is transparent and could remove the need for a central clearing house (currently fulfilled by Visa and Mastercard) – we see limited risk from blockchain as a technology to replace the existing payment rails.

In fact we think recent developments have solidified the roles of Visa and MasterCard (both rated Outperform). Specifically Apple Pay and other "pays" have in effect all elected to use the existing "rails" and make the networks the "guardians" of the tokenization process. In contrast, the "joint ventures" that attempted to change the way consumers transacted (such as Isis/Softcard and MCX/CurrentC) have largely failed.

However, in financial service payments, nobody wants to be left out. We believe bank-to-bank payment systems and trade finance products present the lowest-hanging fruit for disruption. These systems, such as SWIFT, are decades old, have very limited flexibility and face growing security threats (note SWIFT's recent security breaches (FT, May 24<sup>th</sup> 2016)). They are also slow and costly – with cross-border wire-payments taking days to clear with fees as high as 10%. Enter blockchain – a low-cost, instant, virtually unhackable, fully automated, end-to-end transaction system built on a private permission-based network. Such a system would not only enable banks to eliminate costly overheads, but would provide a lower-cost money transfer product attractive to large multi-national organizations with high frequent cross-border funding and trade finance demands.

## Key stock ratings

### ■ **Worldpay (WPG.L) Far from blocked: Reiterate Outperform**

Our analysis suggests fears are overplayed and we continue to believe Worldpay has a sustainable role as a payments facilitator in a structural growth industry. We reiterate our Outperform rating and 300p TP.

### ■ **DH Corporation (DH) Near-term blockchain disruption threat low: Outperform**

DH has partnered with Ripple and developed a private blockchain internally. As a technology provider to 8,000 banks and financial institutions, this puts it in a good position to help banks identify and implement blockchain use-cases, even if the threat is not imminent.

### ■ **Fiserv (FISV) Well positioned to compete but could face competition: Neutral**

Given FISV currently trades at peak multiples, we believe the market has little regard for potential blockchain disruption. Nevertheless, we believe that as blockchain-based applications develop around core financial services, FISV could face competition in the bank technology space.

# Exchanges, registrars and custodians

## Use case

The current capital markets architecture, mature and secure though it is, remains complex and frictional, with reconciliation between >10 ledgers necessary to process trades. Post-trade we still settle T+3; in contrast pre-trade competitive advantage is measured in millionths of a second. The efficiency asymmetry between pre- and post-trade infrastructure could be reduced by implementation of a permissioned shared ledger upon which capital markets transactions are recorded.

In this scenario: (1) The trade could become the settlement; imagine a permissioned public ledger upon which dematerialized share certificates are transacted without friction and at T-near-instant speed. (2) Efficiency could be drastically increased by elegantly replacing the myriad of ledgers maintained in the current architecture with one single source of truth. (3) Due to the proportionality between the speed of settlement and the magnitude of compensation for bearing of risk assumed during the novation process, reducing settlement time has the potential to drastically reduce the cost of credit risk mitigation – clearing. (4) Were dematerialised shares settled and cleared on a blockchain – it could be theoretically possible to embed smart contracts governing dividend and interest remittance, rights issues, proxy votes and other services.

## Analyst view

There is consensus among our global analysts who cover Exchanges, Registrars and Custodians that blockchain offers a new approach to data management and sharing which has potential to change the way securities markets function, making them cheaper and more resilient. Distributed Ledger Technology/Blockchain is likely to lead to a small reduction in the total cost of equity markets (i.e. the revenue base), while at the same time redistributing that revenue to different players through redundancy of current services, cost savings (which may be competed away) and the introduction of new services. It will be up to players across the value chain to jostle for their share of the new pie.

Broadly it appears that distributed ledgers are poorly suited to trading, leaving the core value proposition of exchanges unchallenged. But we and some market participants see scope for vertical integration across the functions that include clearing, custody and registry. The winners and losers in this changing landscape remain hard to predict with clarity, and there are clear regional discrepancies – with Australia more advanced, for instance, and Europe lagging. Our analysts believe a registration function remains necessary to reconcile on-chain and off-chain identity, and CCPs will have a role to mitigate (albeit less) risk and net payments unless T-instant settlement is achieved (which we think is unlikely). However, simplicity and transparency, which are the two key traits of blockchain, should lead to revenue pressures for the custodians – our analysts favor franchises less reliant on custody, the business most vulnerable to disruptive change. To this end, BNY Mellon and Northern Trust screen better than State Street given more diverse business models

On the whole, we are bullish about blockchain's disruptive potential for capital markets infrastructure, but think that the incumbent players are likely best positioned to take large slices of whatever pie is created by blockchain, albeit with some vertical integration.

## Key stock ratings

### ■ **ASX (ASX.AX) – Priced for the bull case: Reiterate Neutral**

ASX will likely be forced to adopt new technology. 7% of ASX's revenue base relates to cash equities clearing, rising if you include other clearing services. The 'blockchain bull' case for ASX will be a small positive for revenues (or at least stable) with a small capital return while the 'blockchain bear' case could see revenue downside, which although difficult to quantify, could be >10%. However ASX is already priced for the bull case at 22x 12m forward P/E – high for a company with low growth and it implies high certainty around future earnings. Therefore we see little room for error in the ASX valuation, meaning downside risk for a more conservative outcome.

### ■ **Computershare (CPU.AX) – Don't forget the bull case: Reiterate Outperform**

Over the last year we have seen a flurry of negative press reports on CPU centered around the challenges that blockchain poses to their registry business. We see these concerns as somewhat overplayed with even our 'bear' case implying only a ~10% earnings impact. The commentary also fails to highlight some of the opportunities that blockchain could unlock for CPU, which under a 'bull' case could contribute as much as ~10% to earnings. We think CPU is priced for the 'bear' case scenario with the stock currently trading on 13x 12m forward P/E or a ~30% discount to the market.

### ■ **Equiniti (EQN.L) – On the front foot: Reiterate Outperform**

Blockchain could be a net opportunity for EQN: our analysis suggests that the evolution of distributed ledger technology ('blockchain') could represent a net positive for the Equiniti equity story over the medium to longer term. We believe there will still be a critical function for independent share registrars in the event of any move towards blockchain and that other parts of the EQN portfolio could benefit from simplified processes and lower costs. We believe that, as EQN's R&D and forward thinking around blockchain becomes more widely appreciated, the stock's discount to the wider sector should diminish and we thus reiterate our Outperform stance.

### ■ **Capita (CPI.L) – DLT may one day define UK public sector BPO: Neutral**

Investors may be prone to focusing on threats to CPI's share registration business. However, we estimate this accounts for only c.4% of group EBITA (and, in any event, see disintermediation risks as low). However, as the UK's Office for Science has already identified significant and wide-ranging benefits of distributed ledger technology to public sector administration, there is a question as to what UK public sector Business Process Outsourcing (BPO), which accounts for just under half of CPI's revenues, will look like in the very long term. It is unclear whether CPI will be able to build organically or acquire the skills required to be a winner under this new paradigm, or indeed at what cost.

### ■ **LSE (LSE.L) – Blockchain – more opportunity than threat: Outperform**

LSE's exposure to Post-Trade applications such as settlement and custody is currently low, but rises to c.10% of pro-forma revenue in the event of the DB1 merger closing. In our view, execution and clearing is here to stay and while clearing and NII make up 28% of LSE's standalone revenue, the company is well positioned to implement new technologies in our view and we think the risks of disintermediation are low. Outperform.

### ■ **Japan Exchange Group (8697) – Little financial incentive: Underperform**

We met with Mr. Atsushi Santo, Head of JPX's Fintech Laboratory. JPX looks set to complete two proof of concept (PoC) tests of blockchain systems as it conducts comprehensive studies to evaluate the potential, and also limitations, of the technology. Although we think there is little financial incentive at the moment, potentially, regulations permitting, future opportunities may exist to leverage blockchain to expand business scope. We rate the stock Underperform as although valuations are reverting to a level justified by profits, this is coming in tandem with increasing investor pessimism on where trading volume—the key profit driver—is headed.



## Financial services

### Use case

Currently financial institutions each maintain their own asset registers, and often these registers are product and/or region specific; the larger banks may have hundreds of ledgers. Not only are these ledgers numerous, but their reconciliation is costly, complex and often requires manual alterations.

Creating single, or perhaps multiple, databases between major banks resting upon a blockchain, it is argued, could reduce these frictions. Richard Brown, of the R3 banks consortia explains: *"Through one global logical ledger, financial firms will move from systems-of-record at the level of the firm to an authoritative systems-of-record at the level of a market. These records would sit logically outside each firm on a shared ledger, accessible only to anybody (or anything, such as an authorized smart contract) with an interest in the assets and agreements they manage."*

### Analyst view

At this stage, we think that the blockchain's immutability and "tamper-proof" properties, as well as the ability for all relevant parties to view the transaction record without undertaking laborious reconciliation, could be relevant for certain payment/transaction related businesses.

The market opportunity appears broadly two-fold: (1) A shared ledger system creates a significant opportunity for cutting costs in a number of areas where current processes are slow and cumbersome. These areas include the processing of trades in securities, trade finance and also in payments, particularly international payments. (2) In addition, there are opportunities on the revenue side. Shared ledger systems combined with better data analytics may enable a much greater understanding of clients. This could lead to more products being sold to existing clients (where current client needs are not currently identified).

### Key stock ratings

- **Goldman Sachs Group, Inc (GS) – Among best positioned to reap blockchain benefits – Reiterate Outperform**

We think direct investments in technology such as blockchain should be quite valuable, to both Goldman's product/knowledge base and its earnings/book value (at monetization). Goldman is a best-in-class capital markets franchise with competitive positioning across myriad businesses. GS invests heavily to sustain that positioning; operating leverage and market share consolidation should drive above-average growth and returns, supporting share price outperformance

- **JPMorgan Chase & Co. (JPM) – Strategic blockchain investments yield results – Outperform**

JPM considers blockchain and DLT the most nascent 'select area of innovation' (JPM Investor Day, Feb 23<sup>rd</sup> 2016); the intention is to explore how this tech can be repurposed to streamline currency, clearing and settlement-reducing latency time and risk (consider the opportunities-reduced funding costs; reduced operating risk/losses/costs) – in addition to more efficient record of securities ownership. The bank is investing both directly and in third parties, with such investment representative of a broader determination to equip themselves to not just face, but lead the disruptive FinTech evolution/threat. CEO Jamie Dimon has been quite clear that "Silicon Valley is coming" (Annual letter to shareholders, 2014); he is also quite clear that JPMorgan will position itself to stay one step ahead. Their increasing tech budget, close links with successful blockchain start-ups and early success



in scaling the capacity of its distributed ledger bolster our positive view – reiterate Outperform.

■ **Experian (EXP.N.L) – Blockchain only a distant and partial concern – Outperform**

While the development of blockchain could potentially be disruptive, both the time scale of creating a unified register with sufficient history to offer a viable alternative to elements of a bureau offering plus the value of having regulated third party entities at the heart of the credit economy suggests to us that the existing approach will be maintained for the foreseeable future. We will monitor any changes but for now we think that even if blockchain does offer a partial alternative over time it will be at least 10 years (5 years to create and 5 years to build usable history) before any potential commercial impact could be felt. Given this time frame and the breadth of Experian's offering we retain our Outperform rating.

■ **Santander (SAN.MC) – Current investments for distant benefits – Neutral**

Santander is amongst the financial institutions investing in blockchain technology. Through its UK subsidiary, it became the first UK entity to introduce a blockchain architecture enabling international payments, and like many of its European peers, it continues to focus on investments for what is often referred to as the sector's "digitalization era". International larger players, such as SAN, are likely to be the main beneficiaries of such technologies, especially if blockchain technology is extended beyond the payment system. For us, it is the regulatory environment that makes an investment decision on the stock difficult, with the bank's CET1 ratios standing amongst the lowest of the sector at times where profitability levels (and thus capital generation) are also under pressure (due to lower revenues in Spain, higher provisions in Brazil, and uncertainty in the UK). Neutral maintained.

## Media

### Use Case

It has been suggested that content like music, and all of its meta-data (detailing rights holders), could be irreversibly recorded on a blockchain. The immutable and timestamped nature of data enshrined upon a blockchain mean that you could potentially create a comprehensive and exhaustive content database – a single 'source of truth' to determine the authenticity of content. It's worth noting that it would not be the content itself (for example .mp3 or .mp4) stored on the database, as has been attempted with previous failed content database projects, but instead would be a 'hash' of the songs file data.

The implications of this are potentially powerful. Were it possible to query this permissioned (content creators/owners would likely be those best positioned to govern consensus) public (everyone can see the blockchain) ledger – it would be easy to confirm the authenticity of the digital content file in your possession. It is not a stretch to imagine media players being optimized such that only content which matches its 'hash' in the blockchain may be played.

Were this blockchain also paired with a distribution platform the potential implications are even broader. Content has multiple rights owners – music, for example has the writers, labels, licensees and the artists themselves. Smart contracts could be embedded in content, creating autonomous rules that would ensure, for example, that once purchased, revenue is correctly distributed to the designated parties. Broadly, blockchain in a content ecosystem could potentially enable more simple attribution, simplify royalty payments, reduce IP related costs, increase flexibility and control over content and provide more, better data.

### Analyst view

Were this to happen, the most practical benefit would be reduction of piracy. Quantifying the potential “piracy opportunity” is challenging and has significant inter-country variance. We nevertheless attempt to illustrate the potential opportunity in the context of the music industry, were a blockchain system capable of reducing piracy to the extent that the 4 most populous EM countries (China, India, Indonesia and Brazil) were to increase spend per capita up to the Global average of \$2, this would result in \$6.1bn or 40% incremental revenue for the Global music industry. Although this is a very simplistic example which does not account for challenges surrounding IP enforcement in the countries analysed and is heavily skewed by India's and China's vast populations and low (\$0.08) spend per capita, it does illustrate that the potential opportunity for the recorded music industry from even a small reduction in piracy (either through a blockchain-based platform or otherwise) is significant.

However, implementation (which requires total adoption) appears challenging:

- **Content databases have failed before.** The International Music Joint Venture IMJV, the International Music Registry IMR, and finally Global Repertoire Database GRD, have all tried, and ultimately largely failed, despite millions in aggregate investment.
- **Content owners have proved they can't work together.** This inability is exemplified by their seeding of current streaming platforms (Spotify, Deezer etc) to ensure a competitive (and therefore cheap) distribution platform.
- **Standard data format does not exist.** A single interoperable data format standard whose codec was intrinsically linked to rights stored on the blockchain would need to proliferate as a single standard. This does not yet exist.

# The Blockchain Protocol

## Understanding blockchain through bitcoin

Bitcoin remains the most noteworthy system predicated on blockchain protocol. Bitcoin has a total 'market capitalization' of \$10bn, daily volume of c.250k individual transactions and peak transaction value of c.\$35m. As a proven use-case for blockchain, bitcoin is the most appropriate lens through which to understand the technology.

**Figure 12: Bitcoin's 'market cap' is in excess of \$7bn after peaking at c.\$14bn in December 2014**

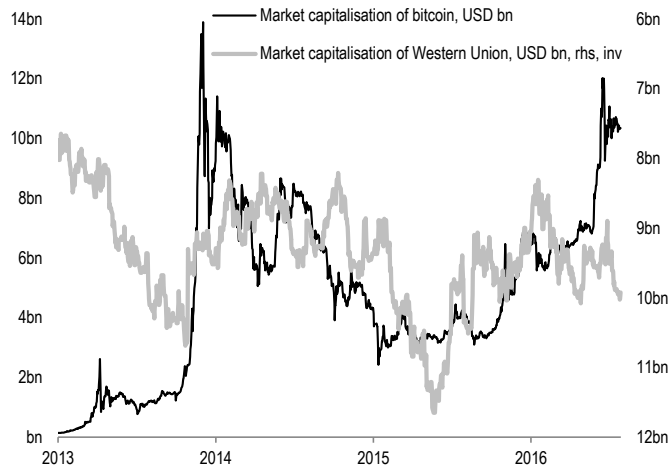

Source: Thomson Reuters Datastream, blockchain.info, Credit Suisse Research

**Figure 13: Daily transaction value peaked at c.\$35m, volume has increased to c.250k**

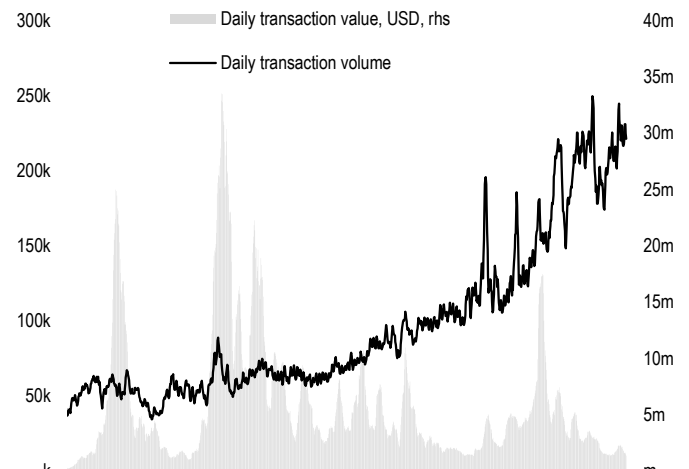

Source: blockchain.info, Credit Suisse Research

Bitcoin is enabled by a network of computers running bitcoin mining software. This software consists of a copy of all past bitcoin transactions in the form of a blockchain (currently c.75GB), and a program which connects to peers in the network and follows a set of rules to authenticate new transactions and add blocks of these to the chain.

Known as a 'cryptocurrency', the bitcoin protocol relies heavily on advanced cryptography. Hash functions are integral in the process of adding to the blockchain, and digital signatures encrypt the transfer mechanism; we look at both in greater depth below.

### Cryptographic underpinnings of bitcoin

#### Hash functions

A hash function is any computation which transforms input data of any size, to output data of a fixed size. The input message can be any sort of data (text, character strings, binary etc.), of any length. A specific set of mathematical transformations are then applied to this message to create a fixed size output (in bits).

In Figure 14 are two examples which illustrate how hash functions convert messages into digests: the first, a very simplistic function borrowed from the SANS institute (2003) accepts 'messages of any length, and outputs a fixed length digest of one-bit. H returns 0 as the message digest if the input has an even number of characters, and returns 1 if the output has an odd number of characters'.

The second, SHA256, is a much more complex and secure hash function. Part of the SHA family (Secure Hash Algorithm), the 256 means the output is 256bits in size; we use it as an example here because it is the exact encryption used by bitcoin.

**Figure 14: Example hash function transformations of random text strings**

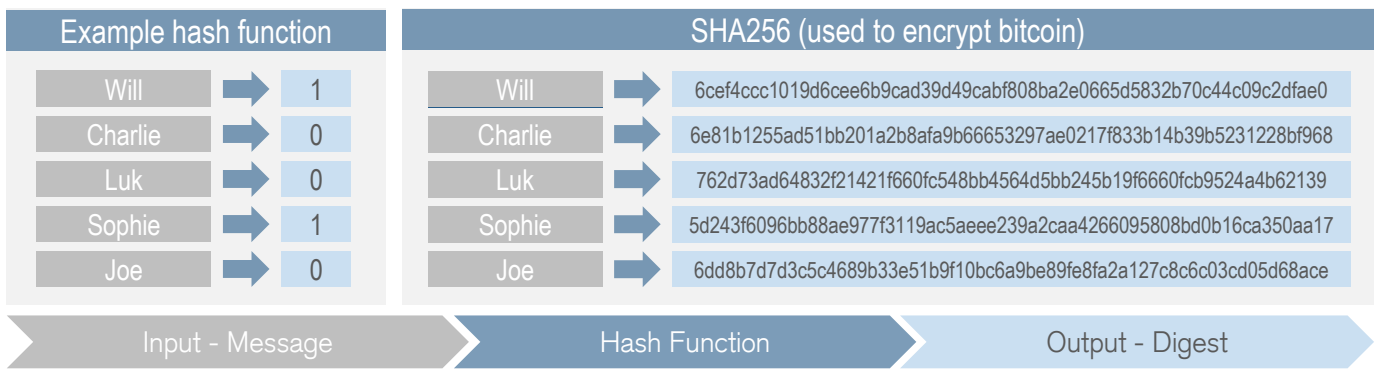

Source: Credit Suisse research, quickhash.com, SANS institute

**Cryptographic Hash function**

The cryptographic power of complex hash functions is that given a single output, it is hard to determine the input. Hash functions are deterministic models; they will always produce a consistent output from a given input. Back-ending this process – generating a message from a digest – is statistically highly improbable; it is a mathematical trapdoor.

A strong cryptographic hash functions digest will be also be similar to an iris; unique, no matter the message. Although it is mathematically impossible to assert total collision resistance (that no input will create the same output), high quality hash functions are generally considered for the most part collision resistant.

It is easy to understand why, even if we were able to commandeer the processing power of the entire bitcoin network, c.1.4bn gigahash per second, a brute force approach to finding a collision in the NSA developed SHA256 would take  $1.33 \cdot 10^{51}$  years. To put that in perspective, our universe is c.13.7bn years old, so it would take 9,672,989,162 trillion trillion times the life of our universe to find a collision.

**Digital Signatures**

Digital signatures are a derivation of public-key cryptography which uses a pair of keys to ensure the integrity and provenance of messages. A message is bundled with a ‘private key’ known only to the sender; anyone with access to the sender’s paired ‘public key’ may then authenticate the message. Think of it like a virtually unforgeable and unique wax seal; the seal’s presence authenticates the sender, gives credence to the content, and prevents non-repudiation.

Three algorithms are necessary:

- **Key generation algorithm** that concurrently generates a private signing key and public verification key. The pair are generated such that a mathematical relationship exists between the two, and the private key may not be derived from the public key.
- **Signing algorithm** that hashes the message and binds the private key of the sending party to the message.
- **Signature verification algorithm** that uses the public key to ensure the corresponding private key was used to sign the digest.

**Figure 15: Process of secure digital signing and verification**

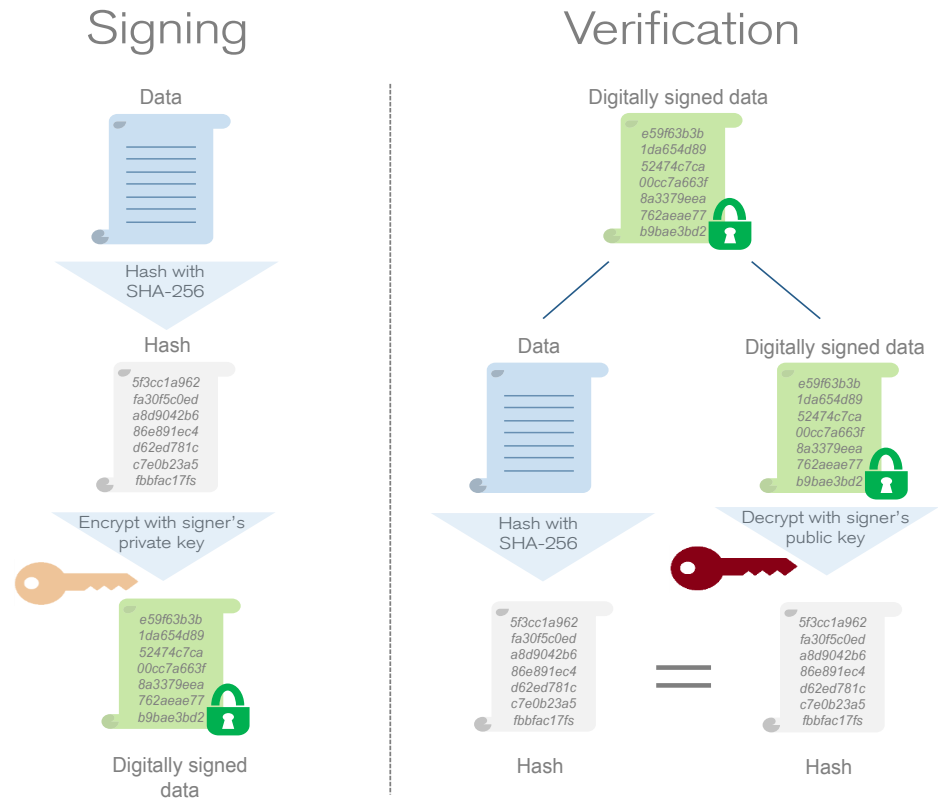

Source: Credit Suisse research

This process has been in use since the late 1970s to determine the integrity and authenticity of a message and enable non-repudiation of its source. It's worth noting that well known digital signature algorithms such as DSA, RSA and ECDSA can carry legal significance in the US, EU, Switzerland, Saudi Arabia, Brazil and India. Identity and ownership of bitcoin is managed by virtue of knowledge of a private key; in this sense bitcoin is a bearer instrument, where knowledge of the private key is synonymous with control over the contents of the paired public address.

**Figure 16: Public and private keys used by bitcoin's protocol**

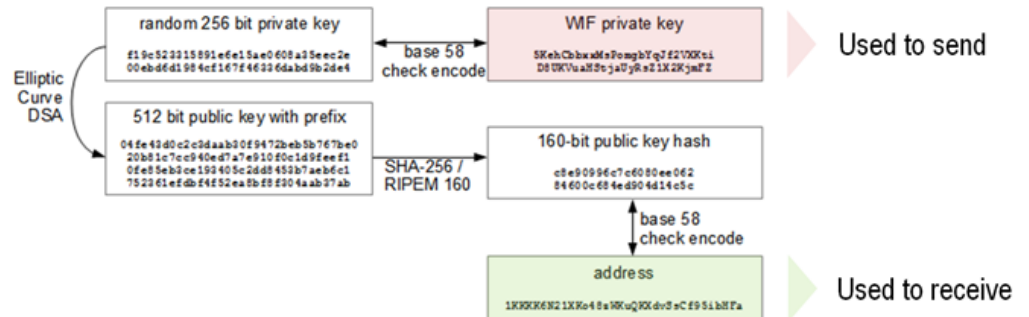

Source: Adapted from Ken Shirriff, Credit Suisse Research

Figure 17: How Alice pays Bob with bitcoin

# Bitcoin transaction lifecycle

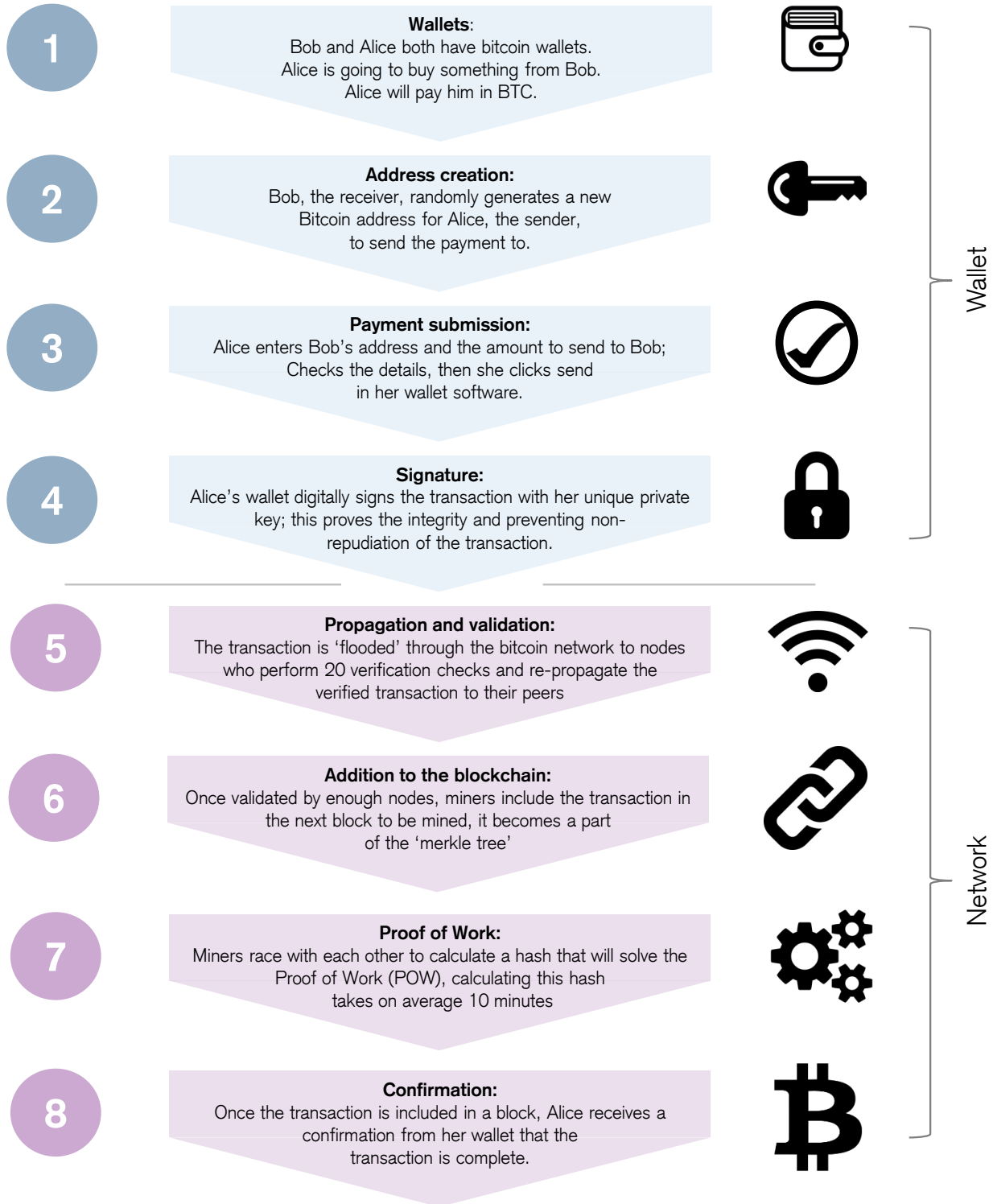

Source: Credit Suisse research, bitcoin.org, weusecoins.com, coindesk.com

### Transaction: Alice transfers Bob a bitcoin

Suppose Alice wants to transfer one bitcoin to Bob: she will generate a random 256-bit private key; this is simply a random number. An elliptic curve transformation is performed which results in a public key from which the private key is unidentifiable – it’s through the mathematical trap door. Various other cryptographic transformations result in a secure public key and its private pair as in Figure 18, generally Alice will use bitcoin ‘wallet’ software, which is free and widely available for download, to generate these identifying codes.

Once successfully generated, and assuming Alice has bitcoins to spend (received more than she has spent), Alice again sends a signed message in a rules based format to Bob’s bitcoin address (also generated using wallet software and associated with a private key) specifying how many BTC are to be transferred. Alice shares her public key with Bob, enabling non-repudiation and confirmation of the authenticity of the transaction.

**Figure 18: Transaction progress of a bitcoin from Alice, to Bob to Sally**

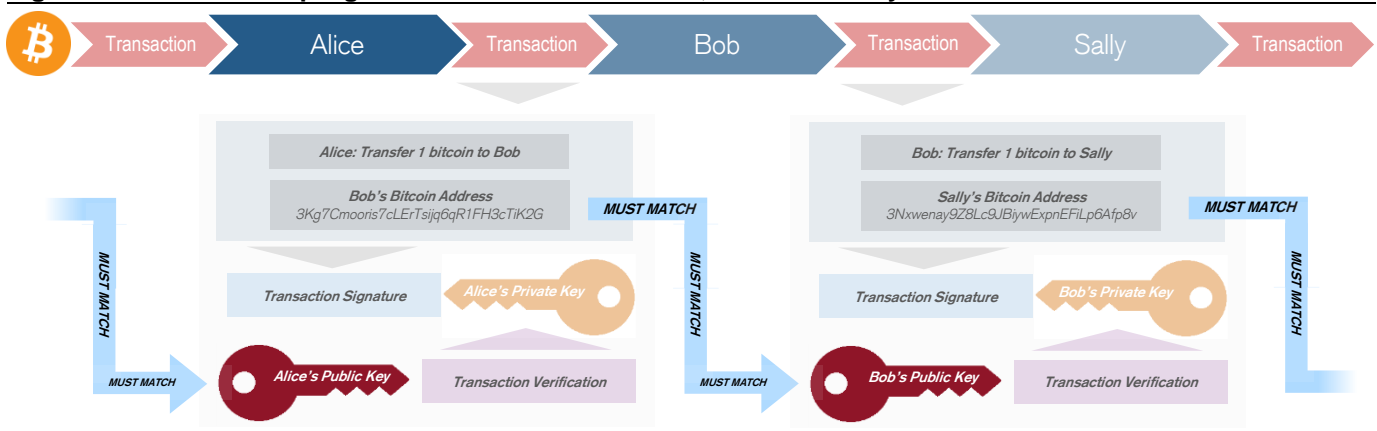

Source: Credit Suisse research

Neither Alice nor Bob may confirm or settle the transaction on their own. Like cash, digital tokens may be forged, and unlike cash, digital tokens are susceptible to the problem of double-spending. This returns us to the trust concepts discussed in the executive summary; traditionally a central third party would sit between Alice and Bob to confirm, authenticate and administer the value transfer. Bitcoin instead devolves authority through a relatively simple structure of incentives enabling confirmation of Alice, Bob and Sally’s transactions by consensus of actors on the bitcoin network who prove their trustworthiness through display of computational power.

### Nodes and Miners

As a peer-to-peer network, bitcoin is underpinned by the peers themselves. A peer is known as a ‘node’, which means any computer connected to the bitcoin network. There are broadly two types of node: lightweight nodes like Alice and Bob who connect through wallet clients, and full nodes who run bitcoin core software. Full nodes are in possession of the entire blockchain (currently c.75GB) and are particularly integral to the system as they not only perform the task of validating and propagating transactions like lightweight nodes, but they also perform the more computationally challenging verification and updating of the shared ledger (blockchain).

Once Alice’s transfer of 1 BTC to Bob has been signed with her private key, and validated by Bob’s client, the valid transaction (roughly 400 bytes of data) is broadcast to all nodes



(both lightweight and full) with whom Bob’s wallet software is connected. Each peer in receipt of the transaction performs a series of 20 checks – including confirming the syntactic correctness of the transaction Alice’s wallet software submitted, verifying that Alice’s public key matches the signature and crucially checking the mempool (record of verified transactions not yet included in a block) and blockchain to verify that Alice has received more bitcoins than she has spent, and therefore has enough to transfer to Bob.

Should the transaction be deemed valid, the node will then re-propagate the transaction to the peers with whom it is connected. This process is known as flooding, as very quickly a new valid transaction will move in an exponentially expanding wave across the entire network.

**Figure 19: Distribution of 5,612 full nodes running the bitcoin blockchain on Tue May 17 2016 07:37:53 GMT**

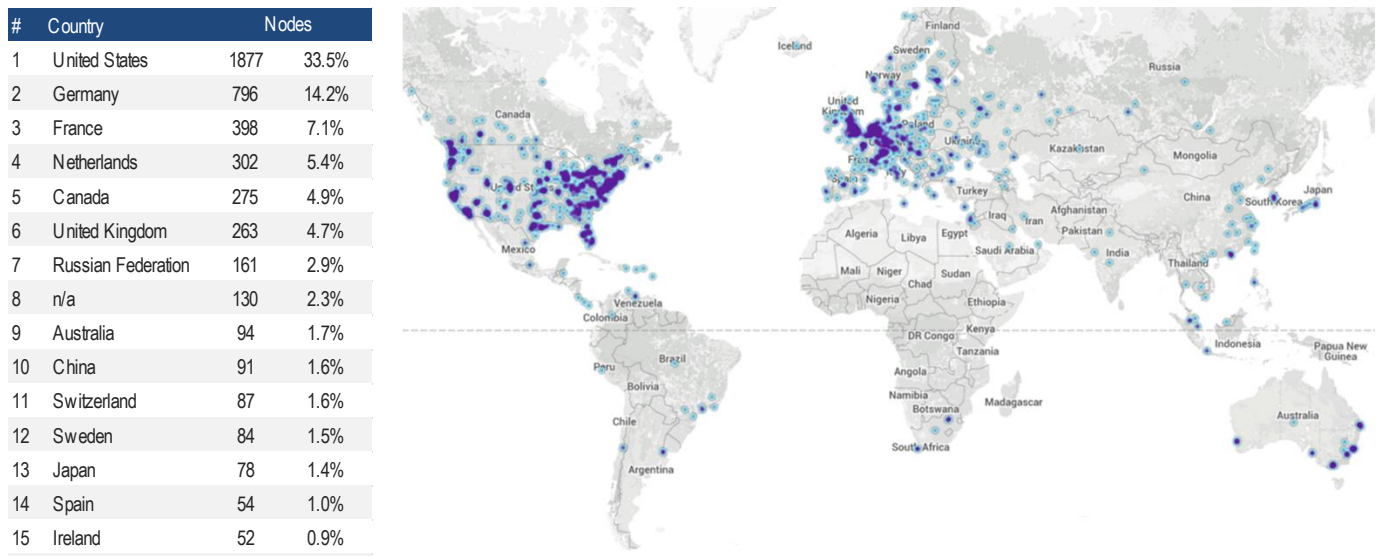

Source: Bitnodes.com, Credit Suisse Research

### Building blockchain

Full nodes not only maintain in their possession a full, complete and up-to-date version of the blockchain, they also independently verify and add to it. This process is known as mining, and is comprised of running computationally intensive software to solve complex mathematical problems. The difficulty of this problem – known as ‘proof of work’ – is adjusted such that it is solved roughly once every 10 minutes (see Figure 22).

Returning once again to Alice’s transaction with Bob, once verified by enough lightweight nodes to have propagated through most of the network, the transaction is aggregated with other valid transactions made since the last block was created. At current rates this would be roughly 1,500 transactions over roughly 9 minutes – see Figure 21.

A definitive hash is arrived at which itself is a result of hashes of all transactions which have occurred since the last block. This ‘merkle root’ provides incontrovertible evidence of every transaction that has occurred, and is arrived at by pairing each transaction with another, hashing the data, then pairing the result with another pair, and hashing again. This exhaustive process is repeated until all transaction data is contained within one final hash, and there is no pair left with which to combine it – this becomes the merkle root.

Thus the merkle root is like the winner of an elimination tournament: the winner of the final is a result of the semifinals, which are a result of the quarter finals, which are themselves a result of the heats. It is due to this cumulative nature that the final ‘merkle root’ is representative of data from every single transaction.



**Figure 20: The strings of data communicating a transaction are hashed, paired, concatenated, and hashed again until a Root hash is formed atop the 'Merkle Tree'**

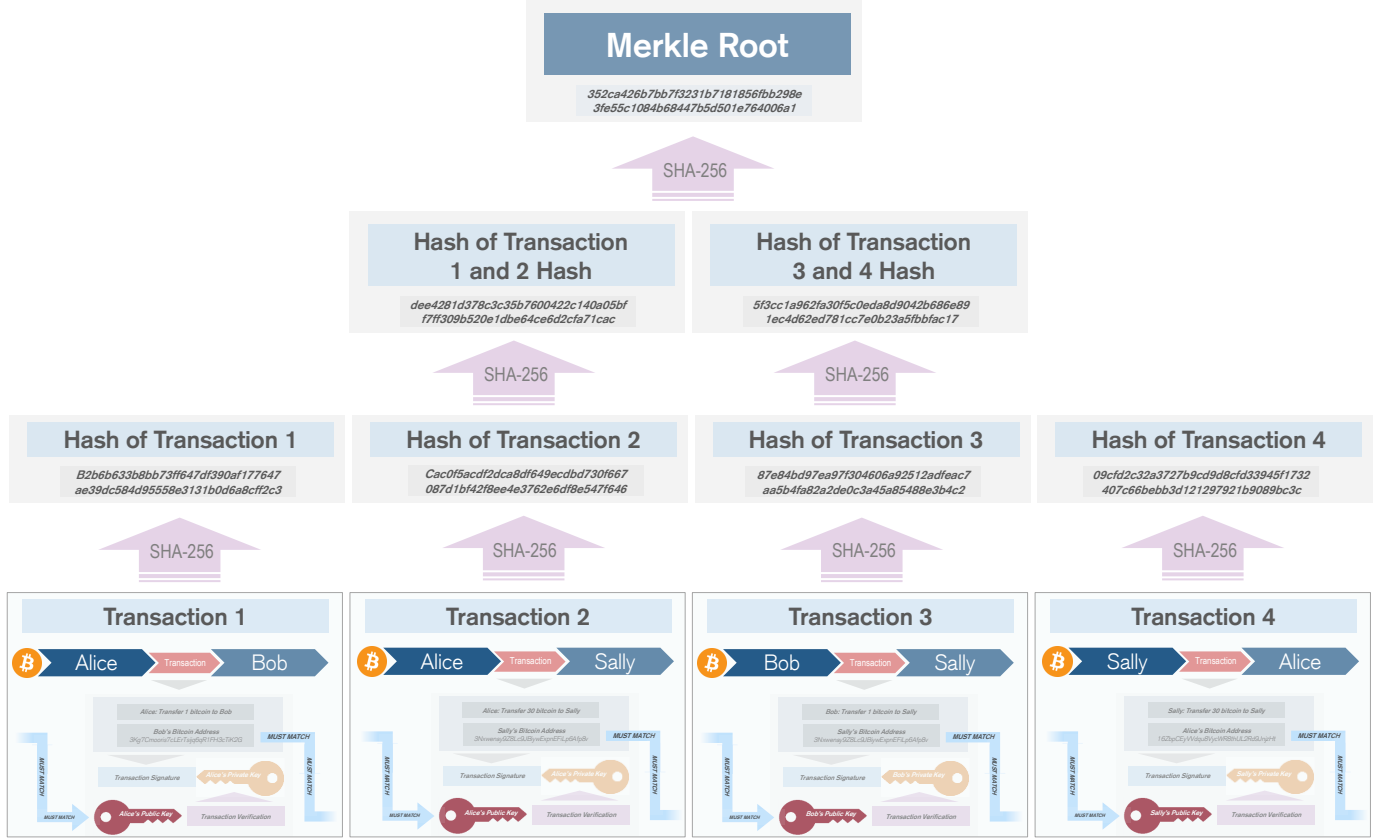

Source: Credit Suisse research

Once calculated, the merkle root, the header of the previous block and a sequence of random numbers are repeatedly hashed by miners – this stage is the proof of work.

**Figure 21: As the average transactions per block increases, so does the average block size in MB**

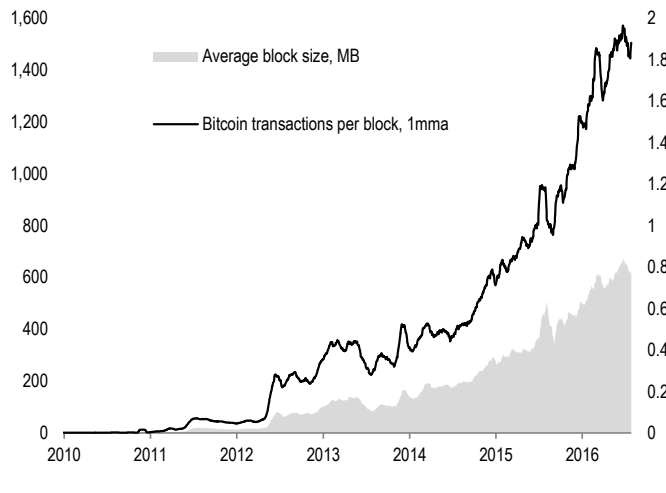

Source: blockchain.info, Credit Suisse Research

**Figure 22: The proof of work difficulty is adjusted such that blocks are added roughly every 10 min**

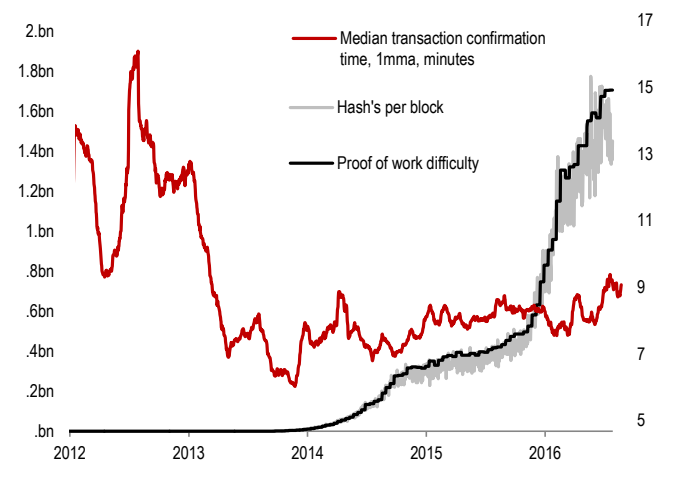

Source: blockchain.info, Credit Suisse Research

**Proof of work**

The proof of work (POW) is predicated on cryptographic hash functions. It demands that for a block to be deemed acceptable, its header hash must be preceded by a certain number of zeros – remember that the hash is a combination of the preceding block, the merkle root of all transactions in the period, and the nonce.

As in Figure 23, the nonce is the moving part of the block header hash, and can be flexed to solve POW. Miners approach this with brute force, hashing the preceding block and merkle root with SHA-256 until they find a nonce which prefixes the digest with enough zeros to satisfy the POW condition. Remember as in Figure 22 the difficulty (number of zeros you must preface the hash with) is automatically altered to ensure that regardless of the processing power (measured in billions of hash calculations a second – Gigahash) of all nodes in the system, solutions to POW will be found every 10 minutes on average.

**Figure 23: Block 415,350 was successfully mined by an AntPool miner in Beijing by adding 209,636,388 to the merkle root and preceding block hash**

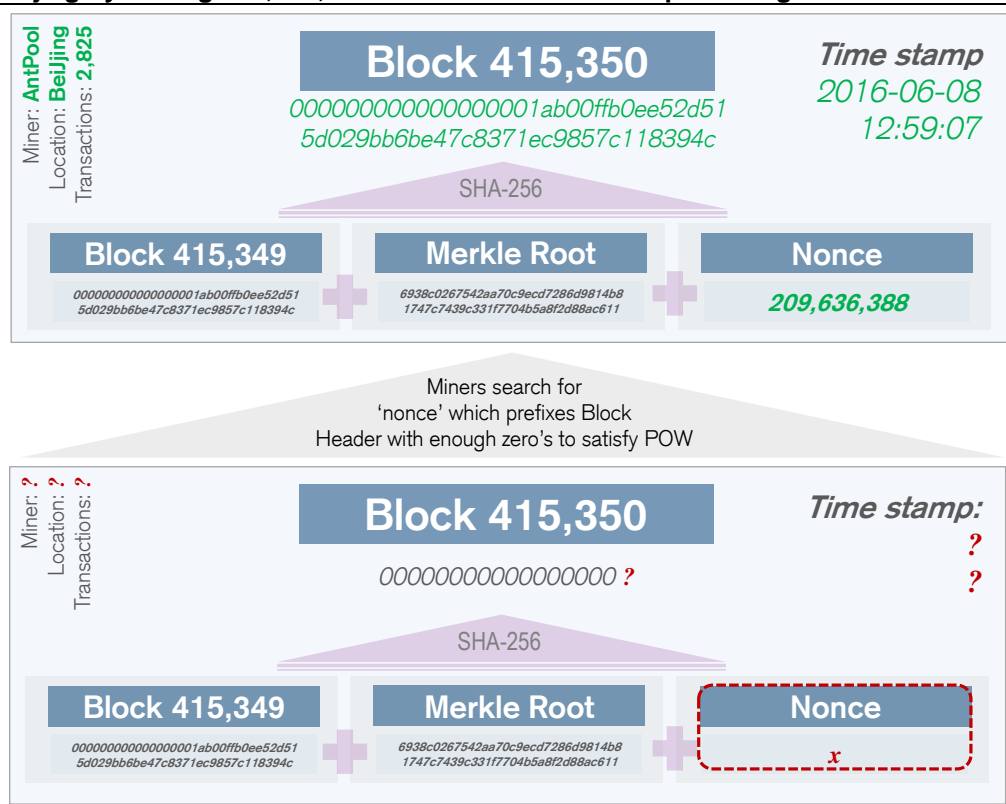

Source: blockchain.info, Credit Suisse Research

Once AntPool has solved the proof of work as in Figure 23, they transmit the new block to their peers across the network. At this juncture full nodes cross reference the constituent parts of the merkle tree to validate the hashed transactions resulting in the merkle root, thereby confirming the block header is clean.

Thus, each full node will verify each transaction twice. Consider Alice and Bob's transaction: it has been verified once during the original 'flooding' and will be checked a second time upon receipt of completed blocks from the successful miner. Once a full node has independently confirmed the validity of AntPool's newly mined block, they will add it to their copy of the blockchain as block number 415,350.



Increasingly the security of bitcoin's blockchain protocol should be coming into clearer focus. As Alice's transmission of one bitcoin to Bob has now been approved by all full nodes, and added to the blockchain, we will step back and revisit the key checks and balances:

- **Primary verification:** Bob, and all full nodes, independently use a rules-based system to verify transactions are valid, and worthy of inclusion in a block.
- **Immutable record:** Independent creation of blocks based on aggregation principles means that each block contains a record of transactions and each (and therefore every) previous block.
- **Secondary verification:** Once a block is readied by a miner to be added to the chain by passing the POW, all full nodes again independently use a rules-based system to verify all transactions in the block before agreeing its inclusion in the chain.

Implementing these checks and balances across a cryptographically secure peer to peer network results in a trustless distributed ledger, updated by consensus and without centralized administration. The security of the blockchain increases with accumulation. Think of it like layers in a geological formation: the most recent blocks at the surface are like the topsoil, lacking density and may be moved with effort, however the deeper you go, the more dense and immutable the material. Eventually the sediment becomes hard rock; immutable, stable and unchanged for many hundreds, if not thousands, of years.

The first six blocks (roughly 60 minutes' worth of transactions) are similar to relatively soft soil, as with enough computing power these could be subject to revision; this is why transactions are considered valid when they are six blocks deep. However as you get deeper, say 100 blocks, roughly 17 hours, down the chain, the probability of any block reversal becomes miniscule.

### **Miners incentives and economics**

We now understand how bitcoin's blockchain is formed, how transactions are confirmed and the cryptographic underpinnings of these processes. The unanswered question remains, why do bitcoin miners devote resource to mining?

Unlike some original peer-to-peer networks like Napster, reciprocity is not the primary incentive for participation. In the same way as gold miners allocate capital to buy equipment and dig in search of the precious metal, bitcoin miners acquire specialised hardware, because every block rewards the miner with BTC. Currently, each successful miner of a block is allowed to write code into their finished block to pay themselves a defined amount of newly created coins. The devotion of computing power by miners acts as a proof of commitment to the blockchain.

As Figure 25 shows, this reward is programmed to halve every 210,000 blocks – roughly four years, capping ultimate supply of BTC at 21 million. Having recently passed the second 'halving date' with the 420,000<sup>th</sup> block mined on the 9<sup>th</sup> of July, miners are now compensated 12.5 BTC per block. Clearly miner's revenue streams are contingent on 1) the value of bitcoin, and 2) the reward era's BTC pay out per block.

Miners tend to be rational economic actors, and therefore will produce where marginal revenue is equal to marginal cost. Fixed costs for miners are mainly the purchase of specialised mining computers, while variable cost includes the power bill of running bitcoin mining equipment. Demand is such for this equipment that Chinese mining hardware firm Canaan Creative (Avalon) has been acquired for ¥3bn, just shy of half a billion USD (Cryptocoinsnews.com, 10/06/2016).

**Figure 25: The number of bitcoins used to reward miners is halves every 210,000 blocks (c.4 years)**

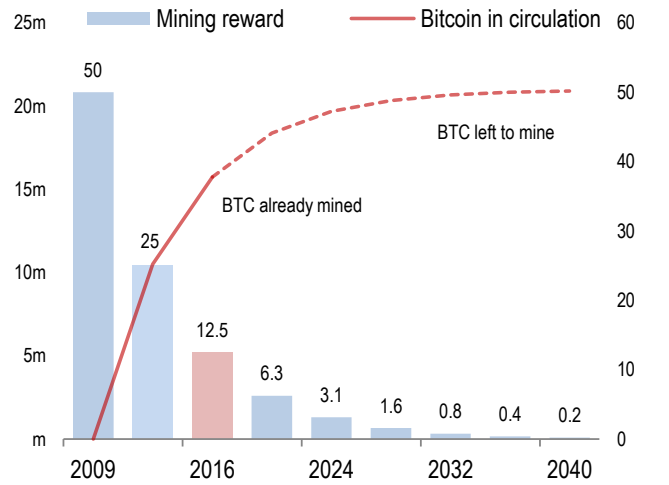

Source: blockchain.info, Credit Suisse Research

**Figure 26: Miners have earned c.1.8bn USD in revenue since 2011, currently c. 1.5m per day**

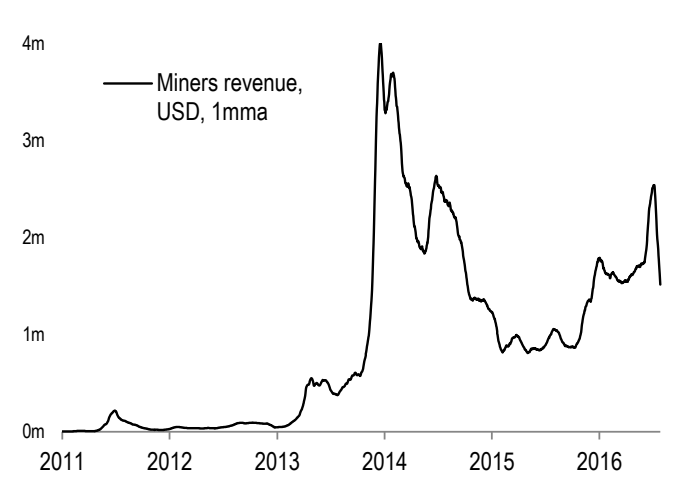

Source: blockchain.info, Credit Suisse Research

At the BTC/USD exchange rate when mined, since the genesis block bitcoin miners have been compensated billions of dollars' worth of new coins. Several questions arise:

■ **How much does it cost to run the bitcoin blockchain?**

It is often claimed that bitcoin transaction costs are negligible. Indeed the direct cost to the transacting party is has averaged 0.013% of daily transaction volume over the last 12 months. These are discretionary fees of c.0.0001BTC intended to incentivize miners to include their transaction in the next block. However, we think this disguises somewhat the true cost of running the bitcoin blockchain.

Evidenced in Figure 28, total remuneration to miners, i.e. the cost of running the blockchain is actually c.1.3% of daily transaction value, roughly 8USD per transaction. In the past it has been much higher (Figure 27), peaking at 8% in 2012, and 6% in mid-2014.

**Figure 27: Although transaction costs are almost infinitesimal...**

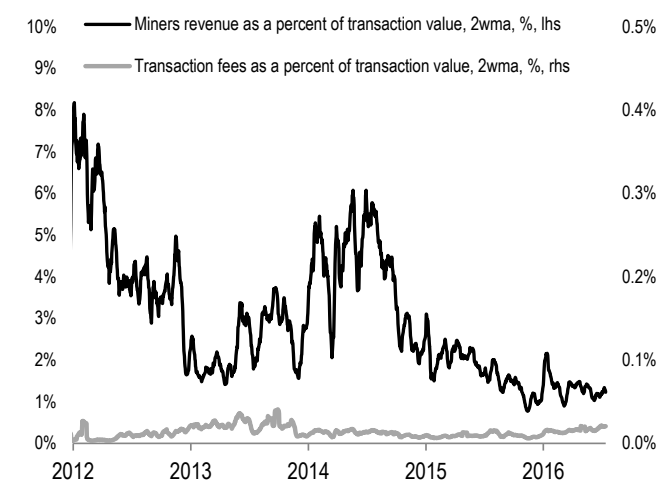

Source: blockchain.info, Credit Suisse Research

**Figure 28: ... miners are being compensated over 1.3% of daily transaction value**

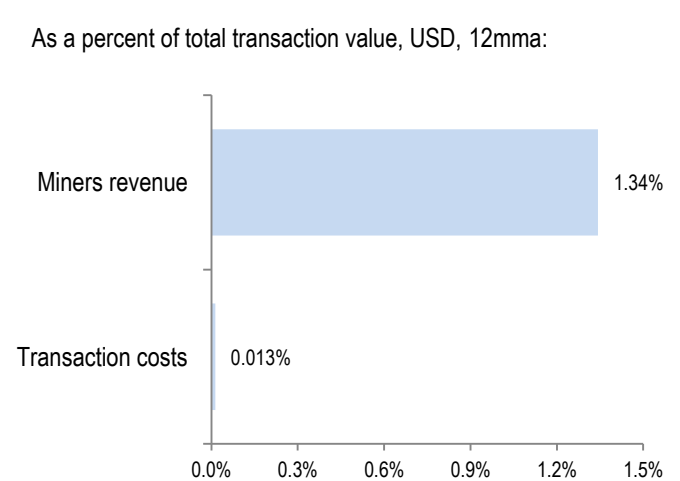

Source: blockchain.info, Credit Suisse Research

Transaction costs are being disguised by inflation. This inherent seigniorage pays for the network, and, due to its inflationary nature, is borne by bitcoin savers. It is the equivalent of central banks remitting newly minted currency to payment processors, removing the cost burden from the merchant.

All parties come to an end, however. Referring again to Figure 25, as the bounty halves every four years or so, eventually there will come a point at which bitcoin mining is uneconomic for nodes without material additional payment from the remitting party. In other words, transaction costs are transferred back to the customer.

Consider the recent halving event: for miners' compensation to remain consistent with a 25BTC reward there are only three levers, either the price increases, users pay more fees, or volume increases. Below we show the necessary quantum of each factor to maintain miner compensation at pre-halving levels.

**Figure 29: Adjustment in price, fees or volume necessary to maintain miners' compensation post-halving event at the pre-halving level**

Reward era	BTC reward per block	Miner compensation per transaction:	Level needed to maintain current miner compensation (all else equal)		
			Bitcoin price	Transaction fees	Transaction volume
Pre-halving	25	USD 7.07	USD 650	USD 0.11	1,400
	0.50x	0.51x	2x	34x	8,156x
Post-halving	12.5	USD 3.59	USD 1,281	USD 3.6	11,417,734

Source: blockchain.info, Credit Suisse Research

The pressure exerted by the halving is evident; Swedish KnCMiner – a mining firm which had raised over \$30m in funding (Coindesk, 27<sup>th</sup> May 2016) – declared bankruptcy at the end of May. CEO Sam Cole explained the decision was pre-emptive ahead of the halving: 'Effectively our cost of coin – how much we produce the coins for – will be over the market price. The price is now (roughly) \$480. With all of our overhead, after July, the cost will be over \$480. All of the liabilities we'll have after that time will be too high.'

■ **Why do we need to pay?**

Bitcoin doesn't function without blockchain, and blockchain doesn't function accurately without miners. If miners lack the incentive to buy equipment, download the blockchain, and run mining software, the blockchain will cease to be updated.

By turning the verification process into a first-past-the-post race in which anyone with the hardware and an internet connection can participate, bitcoin mining becomes a market economy in which producers will increase supply until marginal revenue is equal to marginal cost.

This is key not only because it incentivizes the correct formation of blocks, but also because it induces competition. This competition reduces the likelihood any one party gains control over the entire network – known as a 51% attack. Should any one party have more than half of the network's hash-power, they theoretically have alteration power over the blockchain.

Although in reality control over 51% of the hash-rate (network power) is not a tipping point, instead the probability of mining enough consecutive blocks to cheat the network simply increases. Below we have calculated the recursive probability of a six block streak given different hashrate shares, and find that the probability a miner with 30% of the hashrate mining six consecutive blocks in a week to be over 40%.

Thus we accept a hashpower attack as a distinct possibility, but caveat this with several points. 1) Should the network be compromised, the value of BTC will drop; as miners are

compensated in BTC their incentive is to maintain the blockchain's integrity. 2) Should a miner gain a large hashpower share, transactors could simply increase the number of blocks 'deep' a transaction needs to be considered confirmed. 3) The blockchain cannot easily be rewritten historically due to checkpoints build into blocks implemented by Satoshi in a beta version to combat exactly this type of attack.

**Figure 30: Distribution of blocks mined between 6<sup>th</sup> -12<sup>th</sup> June 2016**

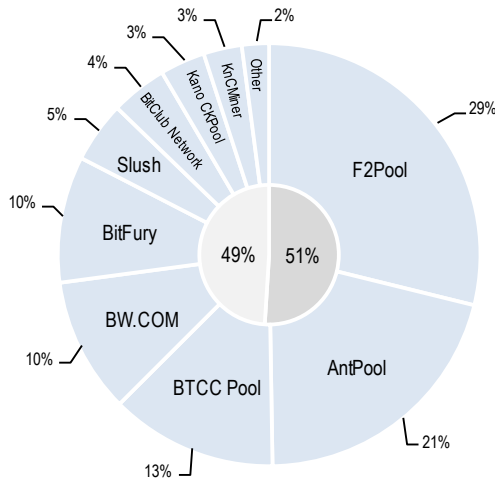

Source: blockchain.info, Credit Suisse Research

**Figure 31: The probability F2 pool mining six consecutive blocks is surprisingly high**

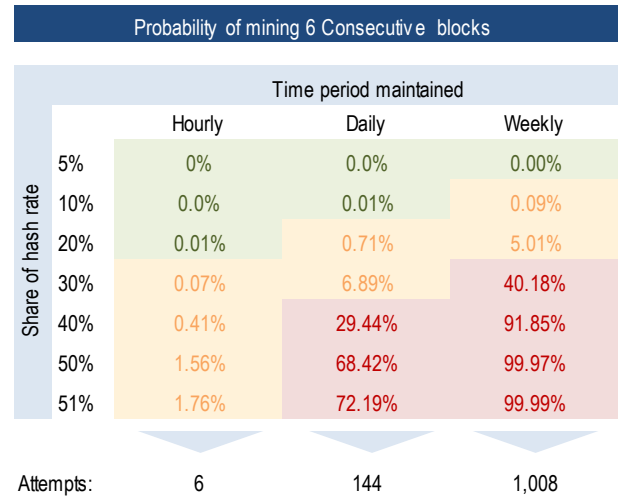

Source: Credit Suisse Research

Competition induced by coin-reward is also important as the processing power invested is used as a metric to determine which decentralized participants are trustworthy enough to add 'truth' to the blockchain. This is important: if a malicious node wanted to change a block 20 deep, it could. However as the hash functions we discussed previously link each block to the last, to prove it as 'truth' to the rest of the network, the malicious node would have to go back and re-do the computationally intensive POW for those 20 blocks.

In an environment where difficulty is regulated by competition, POW ensures this would take so much energy as to be uneconomic. This underpins confidence in the bitcoin blockchain given how much work has gone into it, and therefore how hard it would be to replicate.

The rewards-based system has resulted in competition so intense it has been described as an arms race. In mid-June miners were making upwards of \$3m a day – potentially a >\$1bn annual revenue opportunity. Assuming miners are

1. rational actors, who:
2. treat their hardware acquisition costs as sunk,
3. intend to sell their coinbase reward at the market price once mined, and,
4. pay for their electricity,

... then the network's production decision is simple: if the daily electricity bill is greater than 1,875BTC at the current market rate, then run machinery. Naturally this attracts miners to compete by increasing the amount of computer power they run until their marginal cost of electricity equals their marginal revenue.

This has several implications:

- **Energy inefficiency:** The total hashrate (the number of brute force calculations the network can achieve) is 1,630,722,753 GH per second. Given a conservative estimate of MW:GH at 0.3, the total network power draw is c.500MW.
- **Race to the bottom:** Electricity prices exhibit a wide regional skew, and miners based in regions with lower electricity costs have a competitive advantage, leading to a high concentration of the hashrate in lower electricity cost locations.
- **Centralisation:** The more computationally intensive POW becomes, the fewer mining nodes that are able to compete. Originally bitcoin could be mined on a normal desktop computer's CPU. However as the POW difficulty has increased exponentially along with the value of the incentive, mining has become the preserve of those with the resources to invest in and run capital intensive custom mining equipment.

An inside look at the sophistication and capital intensity of mining came when In February 2015 the online technology magazine Motherboard reported on a visit to a Chinese bitcoin mining farm housed in a repurposed Liaoning factory. Only one of six sites maintained by four businessmen, it had over 3,000 ASIC miners, generating temperatures (c.100 degrees in summer) such that constant cooling was required. Full time operators and technicians inhabited the factory despite the drone of industrial cooling fans. All six of these farms ventures accounted for only 3% of the bitcoin hash-rate in February 2015, or at the current hash-rate, only 0.7%. It is easy to see how increasing difficulty leads to increasing centralization.

**Figure 32: Electricity prices exhibit a large regional skew leading to geographical centralization**

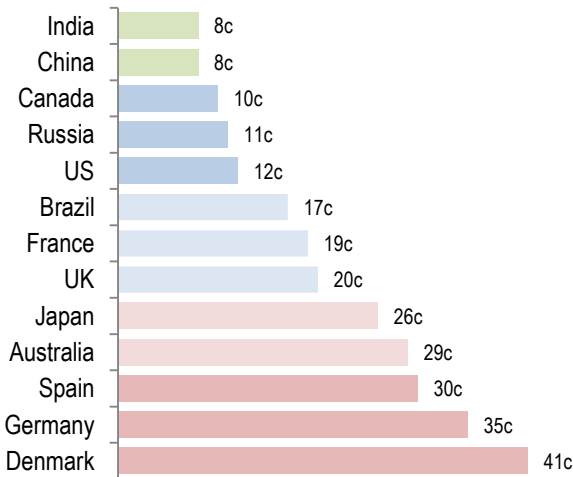

Source: Credit Suisse research, ovoenergy

**Figure 33: Bitcoin draws more power than Facebook (2012), Google (2011) and Ebay (2013) combined**

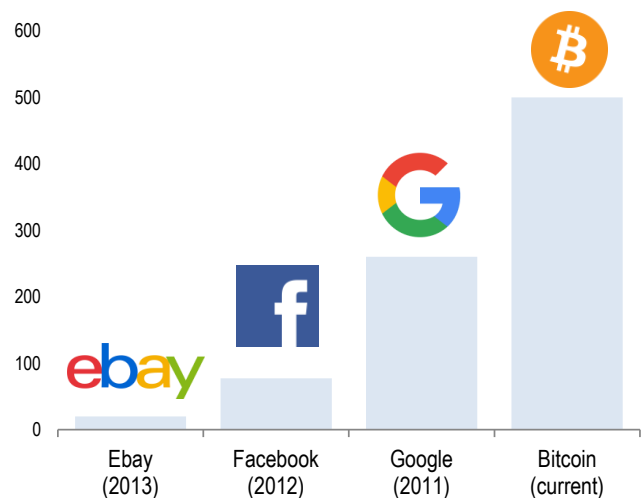

Source: Credit Suisse research, motherboard, datacenterknowledge



## 13 Blocks to Bitcoin Dominance

- Transaction confirmation is slow:** Transactions do not appear in the blockchain until they have been entered into a block. While transactions with fees are generally added within c.9 minutes, transactions with lower fees can take 40 plus minutes on average. Of course once recorded in the blockchain, transactions shouldn't be considered settled until they are six blocks deep – another 60 minutes.
- Costs are hidden, not removed:** The energy intensive and expensive transaction confirmation process (mining) is incentivized by the coin-reward which itself is funded by the issuance of new BTC. Recently halved from 25BTC to 12.5BTC per block, this raises the questions over future funding gaps, and energy inefficiency. The online technology magazine Motherboard has modeled out the bitcoin network at current growth rates, and concluded that by 2020 the total bitcoin continuous power consumption could rival that of Denmark.

**Figure 34: Confirmation time can vary widely**

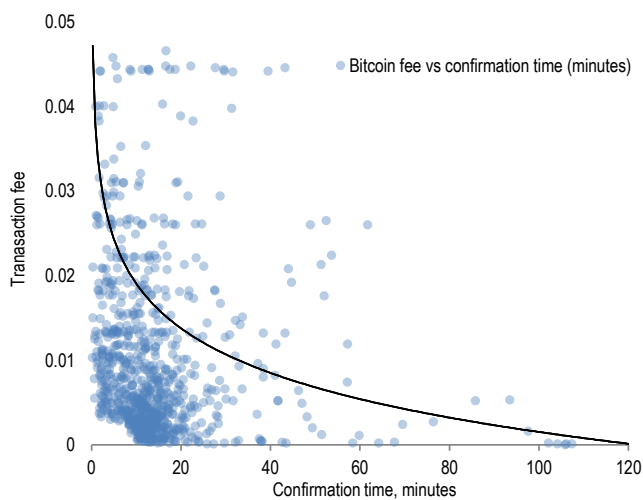

Source: blocktrail.com, Credit Suisse estimates

**Figure 35: The network 'funding gap' is made up by issuing newly minted BTC**

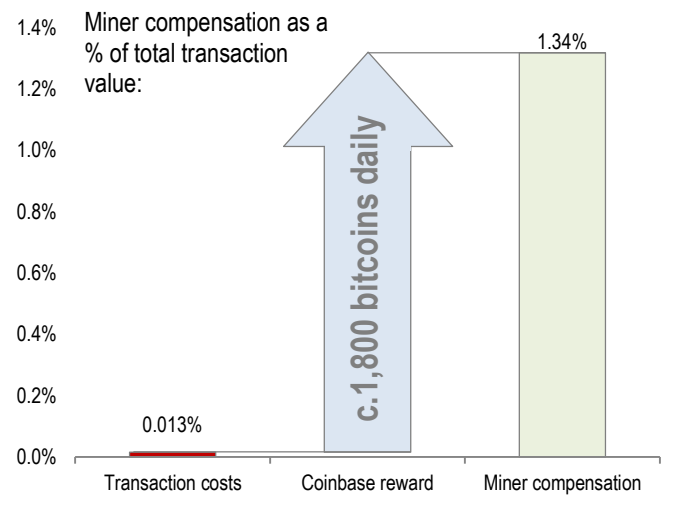

Source: blockchain.info, Credit Suisse Research

- Failure points remain:** BTC users tend to use exchanges to convert fiat to BTC and vice-versa, and wallet software to facilitate transactions—both of which take on responsibilities akin to 'trusted third parties,' and are therefore susceptible to fraudulent behavior. A case in point was Tokyo-based Mt Gox, an exchange which at one point in 2013 was handling over 70% of all bitcoin transactions. In early 2014 Mt Gox filed for bankruptcy protection and announced \$450m worth of bitcoins (BTC850k) were lost. To this date only 24% of those lost coins have been recovered and ex-CEO Mark Karpeles has been charged with embezzlement by Japanese prosecutors (BBC, August 1<sup>st</sup> 2015).
- High-profile legal problems:** Bitcoin's decentralized pseudo-anonymous nature may make it susceptible to illicit transactions. For example, bitcoin gained notoriety as the token of exchange on 'darknet market' Silk Road, which sold over 10,000 products, 70% of which were reportedly illegal drugs, in addition to fake drivers' licenses, weaponry and an assortment of other legal and illegal items. Silk Road was shut down by the FBI in late 2013, and its founder Ross Ulbricht sentenced to life in prison (The Guardian, May 29<sup>th</sup> 2015).

Bitcoin has also been cited as a potential medium for money-laundering and illicit capital flight. Earlier this year Dutch police arrested 10 people accused of laundering

large amounts of money through sales of the 'shadowy virtual currency' according to prosecutors (The Guardian, 20<sup>th</sup> January 2016). Large Chinese volumes suggest to some that bitcoin may be a medium for 'hot money' flight out of a country whose efforts to control capital flight controls have recently been redoubled<sup>1</sup>.

**Figure 36: Chinese yuan transactions have dominated bitcoin trading volume**

Bitcoin trading volume by currency;  
Data from 13/06/2016

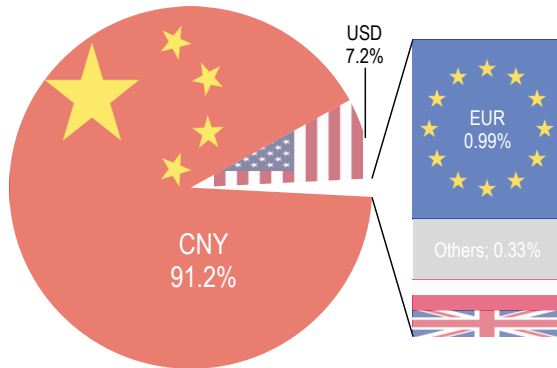

Source: Bitcoinity, Credit Suisse Research

**Figure 37: Mt Gox became the dominant BTC exchange before collapsing in mid-2013**

Bitcoin trading volume by BTC exchange  
Mt Gox had 99% of volume in mid 2012

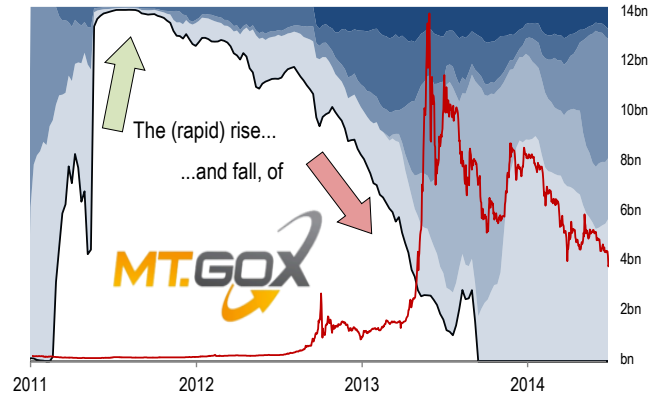

Source: Bitcoinity, Credit Suisse Research

- 5. Extreme volatility:** BTC/USD as an asset class is more than 11x as volatile as cable (even post-Brexit), and 3x as volatile as oil. This instability greatly reduces its utility as a value store and payment method.
- 6. Adoption:** As in Figure 39, bitcoin appears to have reached the 'chasm' stage of the technological adoption life-cycle, where usage must cascade from early adopting 'tech enthusiasts' and 'visionaries' to a mainstream market comprised of 'pragmatists' and 'conservatives'. It may be difficult for bitcoin to cross the chasm, with any crossing likely to first require solutions to many of the challenges we outline here.

**Figure 38: Since inception, bitcoin has been 3x as volatile as Oil, and 11x as volatile as cable**

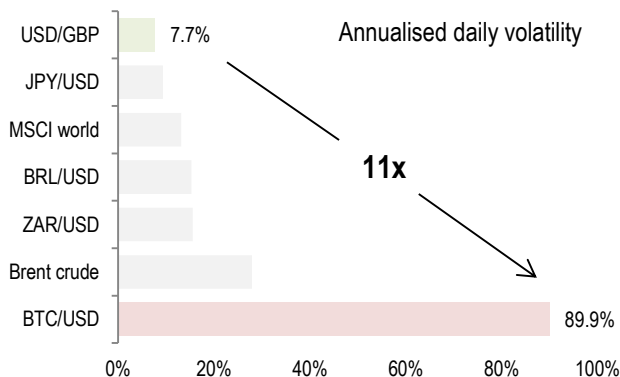

Source: Thomson Reuters DataStream, Credit Suisse Research

**Figure 39: The path to more mainstream adoption appears tricky and unclear**

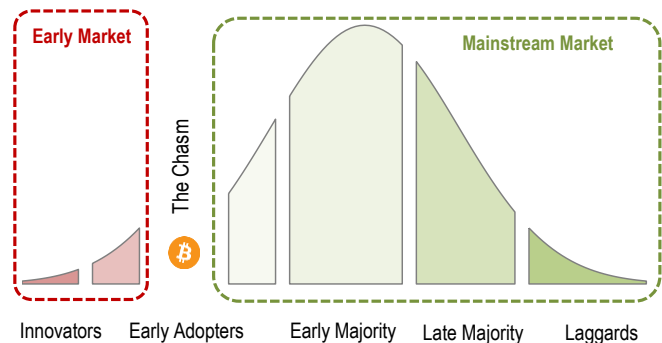

Source: Credit Suisse research, Biznology

- 7. Scalability:** VisaNet is capable of processing 56,000 transactions a second and handles a daily average of 2,000 bitcoin on the other hand, given a 1MB/block size limit and performance in a recent 'stress test', is limited to around 700kb of data (three

<sup>1</sup> Ju, Lan; Lu, Timothy; Tu, Zhiyong. (2015) Capital Flight and Bitcoin Regulation. International Review of Finance

transactions) per second. To truly compete as a payment network, the bitcoin blockchain would likely need to be capable of scale comparable to large payment processors to gain mainstream relevance.

- 8. Internal conflict and inertia:** Changes to the bitcoin protocol to increase scalability or update security are recognized as necessary to introduce new features or prevent network abuse (Bitcoin.org). The debate relating to the block-size scaling issue appears to be between two factions. 'Bitcoin Core' developers are against a block size increase, believing an increase in block-size and associated increase in POW complexity will reduce the network's de-centralization as fewer nodes have the computational power necessary to compete. Conversely the 'Bitcoin Classic' faction support block-size increase to 2, or even 4MB.

The infighting has led to influential developer Mike Hearn proclaiming bitcoin's failure due to failures of the community ([The resolution of the Bitcoin experiment](#), 14<sup>th</sup> January 2016) Potential risks include bitcoin's growing pains intensifying should the technology 'cross the chasm,' developer infighting and intransigence, internal conflict resulting in decision inertia, and bitcoin potentially failing to adapt to match user demands at the protocol level.

**Figure 40: The average daily block size is quickly approaching the 1MB size limit**

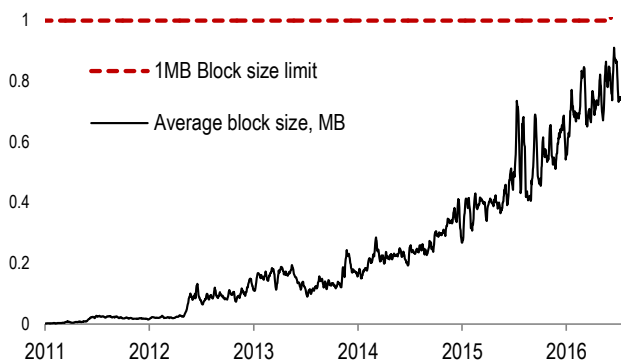

Source: blockchain.info, Credit Suisse Research

**Figure 41: Bitcoin's peak daily transaction volume was only 3.3% that of Visa's daily average**

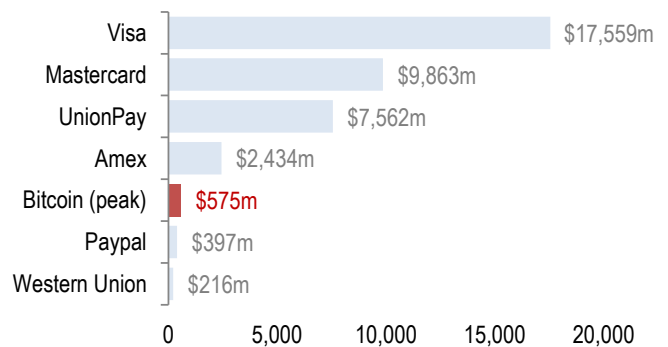

Source: Coinometrics, Statistica, Credit Suisse Research

- 9. Reduced decentralization:** Originally bitcoin nodes could mine with just a normal CPU; however as the relative proof of work difficulty increases, the amount of active miners decreases, centralizing mining in the hands of fewer nodes. This is because as barriers to mine (POW difficulty) rises, higher capital investment in hardware and higher variable electricity costs are necessary to compete. This fundamentally conflicts with bitcoin's founding ethos, and reflects the inherent trade-off between decentralization and network scale.

Bitcoin nodes have also centralized geographically. Electricity prices exhibit significant cross-border variance: compare an average cost per kilowatt-hour of 12 cents in the US, with some Chinese mining farms reportedly paying as little as 4 cents per kWh. Rational miners engage in a race to the bottom, producing in the geographical location where the marginal cost of mining is the lowest.

- 10. Regulation:** Regulatory risk is inherent for disruptive technologies. Although Eastern regulators have taken a relatively strict line on cryptocurrencies, the looser stance in the West means that on balance the regulatory climate is relatively benign.

However the Financial Stability Oversight Council's recent annual report (comprising representatives from the US Treasury, Fed and SEC) highlights concerns that 'distributed ledger systems also pose certain risks and uncertainties ... it is possible

that operational vulnerabilities associated with such systems may not become apparent until they are deployed at scale' (FT, June 22<sup>nd</sup> 2016). This indicates a possibility of currently permissive geographies tightening cryptocurrency regulation in the future should the technology cross the chasm to the mainstream.

**Figure 42: Bitcoin regulation is relatively benign in the West, less so in the East**

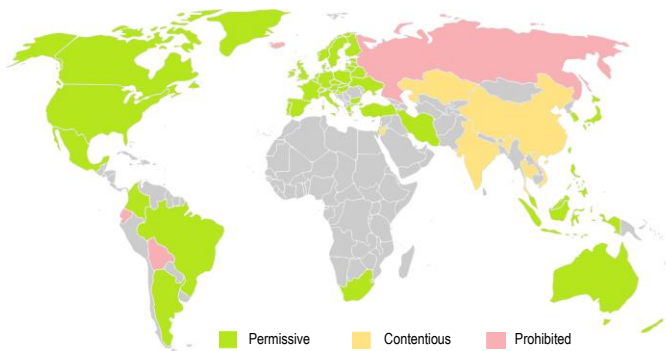

Source: Coindesk, Credit Suisse Research

**Figure 43: The bitcoin mining pool has consolidated since early 2015**

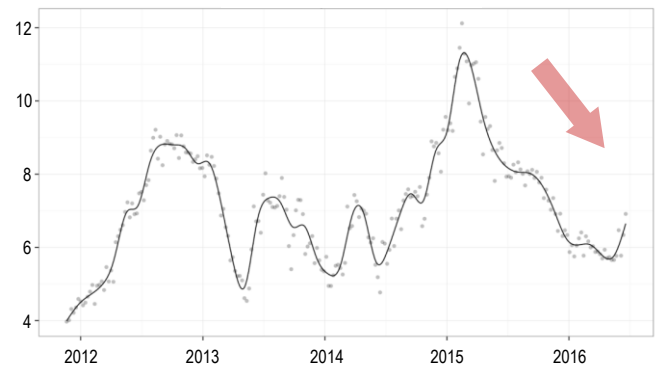

Source: organofcorti, Credit Suisse Research

**11. Irrecoverability:** It is a testament to the security of the network that should your private key be lost, the BTC associated with that address are fully unrecoverable. Equally, it is a barrier to widespread adoption. Imagine if you lost the password to your email account and you could never get it back. Worse still, should anyone else possess the password, they may assume your account, and you have no control. Although we appreciate the security, we view the lack of recoverability as a barrier to mainstream appeal.

This irrecoverability leads to introduction of failure points. Because it is difficult to control an account determined by virtue of knowledge of a private key alone, an entire ecosystem of intermediaries (exchanges) and facilitators (wallets) have developed, themselves each representing a potential failure point.

**12. Irreversibility:** Lacking a trusted central party, there is nobody who can be appealed to or arbitrate disagreements between transacting parties. Should you, for example, send bitcoins to the wrong address, once broadcast to the network the transaction is only reversible at the discretion of the receiving party. There is no authority or mechanism for error correction.

**13. Unguaranteed security:** There is no mandated minimum security threshold for the bitcoin network. The blockchain would continue to be updated at a total hash-rate of 10/s, or when a single node had 100% of the hash-power.

As the hash-rate is a proxy for bitcoin network security, and is proportionate to miner compensation, there is a possibility that the coin-reward sequentially decreases, transaction fees per block may not rise in inverse proportion to the coin-rewards decrease (on a BTC or USD basis). This would result in a reduction in the network's security, making the bitcoin blockchain more vulnerable to a malicious hashpower attack.

**Figure 44: Transaction costs must rise to maintain consistent miner compensation**

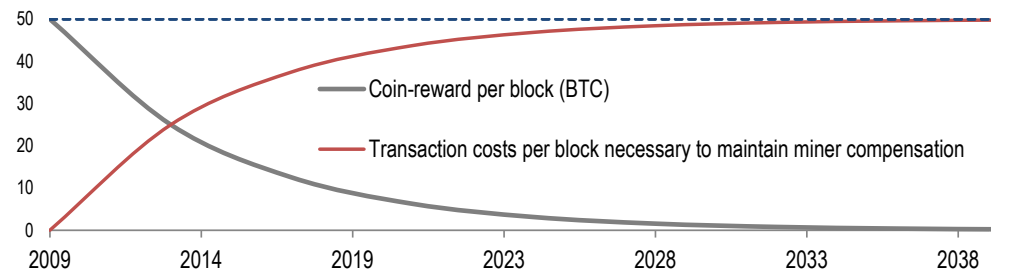

Source: blockchain.info, Credit Suisse Research

## Separating Blockchain from Bitcoin

While in our view, many barriers to mainstream adoption mean bitcoin doesn't appear to present a disruptive threat, blockchain shared ledger technology (SLT) may have features that could prove disruptive to multiple industries. We like to see the disruptive benefits of this technology in three ways:

- **Immutability of record.** There is an audit trail.
- **Disintermediation of trust.** Less reliance on trusted third parties.
- **Smart contracts.** Self-executing commitments, fulfilment of which can be trusted.

**Figure 45: The three disruptive benefits of blockchain, and where they could potentially be beneficially implemented**

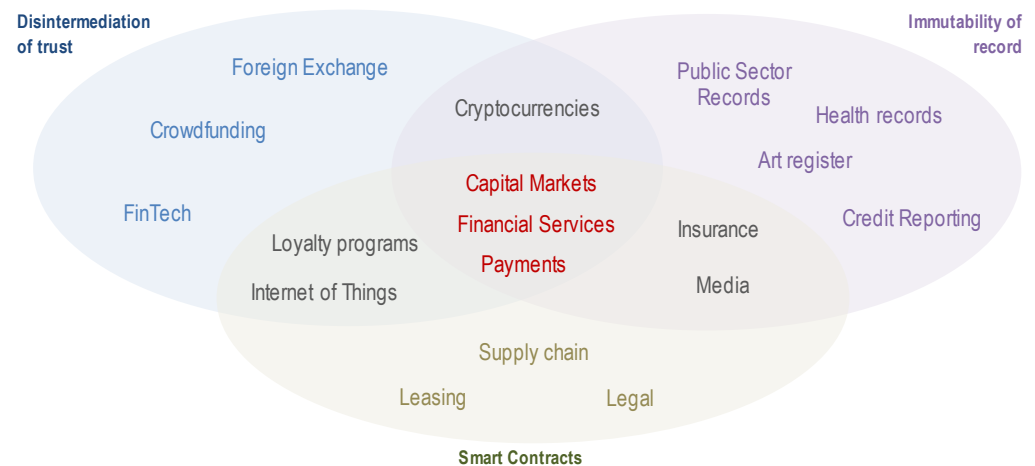

Source: Credit Suisse research

We think about the difference between bitcoin and blockchain as similar to the difference between hypertext transfer protocol (HTTP) and the internet. HTTP is the protocol created by Tim Berners-Lee which hyperlinks text nodes to each other and upon which the internet – a distributed information exchange system – sits. Similar to HTTP as the foundation stone of the internet, blockchain is a protocol, and bitcoin the application for a distributed value exchange system.

Some have gone so far as to say that blockchain is the missing link of the internet. Valery Vavilov, founder of Bitfury, notes that the internet as a medium has drastically altered the way we move almost every kind of information (text, voice, video etc.) with the conspicuous exception of value ([The Missing Piece of the Internet is here: 5 Fundamental Facts Everyone Needs to Know About The Bitcoin Blockchain](#), March 10<sup>th</sup> 2016). Asset transfer traditionally required a trusted third party outside of the network. However with the displacement of intermediaries enabled by a single 'source of truth' curated by participant consensus, reliable asset exchange across the internet potentially becomes possible.

We think a shared ledger has many advantages over classic centralized systems. Maintaining a distributed authoritative 'source of truth' rather than siloed ledgers has the potential to drastically reduce duplication, decrease transaction costs and improve transparency. We appreciate the security of decentralization; in November 1917 power was so centralized in Russia that to control all 17 km<sup>2</sup> of Tsarist Russia, Lenin's Bolsheviks had only to capture several key buildings (telephone & telegraph buildings, railway stations, bridges and the winter palace), of one city (Saint Petersburg). Devolution of power to the margin increases the rigidity of any network.

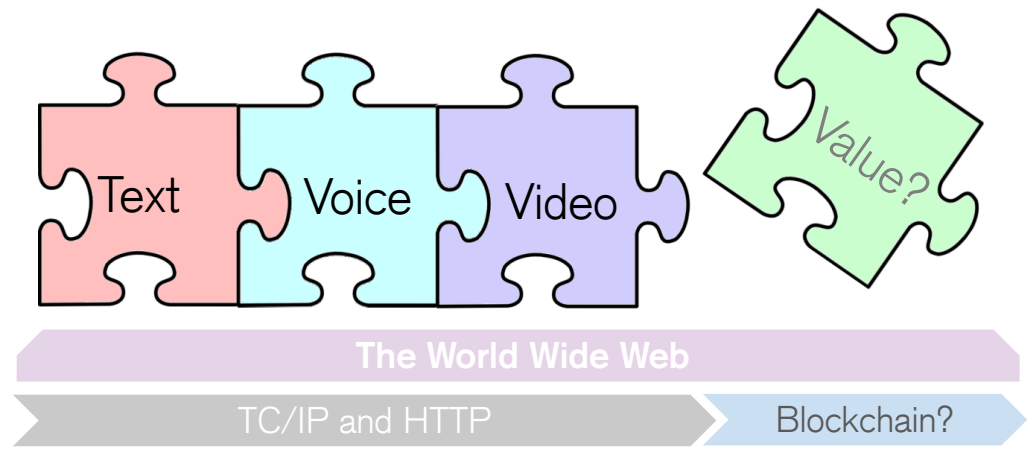
**Figure 46: Some consider blockchain to be the 'missing piece' of the internet**

Source: Credit Suisse research

In this section we move beyond the bitcoin application of blockchain technology, attempting to more fully understand potential blockchain implementations and interrogate potential roadblocks in its widespread adoption.

### Benefits of blockchain

For the most part, asset registers currently consist of: 1) legacy database systems hosted on the servers of a single organization, and 2) systems either licensed or internally developed respond to queries by communicating the requested information.

They tend to be complex, centralized systems with high costs associated with maintenance – a single failure point – and require reconciliation with other centralized systems, both internal and external. In contrast, shared ledger systems, where every party has a copy of the ledger and has to agree on its updates, offers an independent, interlocked record that is immutable, secure and driven by consensus. They have the potential to be faster, cheaper, more industrious and more secure than legacy systems. This is illustrated by the comparison below:

#### Centralized system: Encyclopedia Britannica

Each 17-volume 'Macropaedia' was the result of around 100 full-time editors, and over 4,000 contributors. Updates required the collaboration of editors and contributors, re-publishing, and purchase of the expensive set. Control was centralized in the hands of the publisher and transfer and retrieval of information required much time and great cost.

#### Distributed system: Wikipedia

In effect a decentralized peer-to-peer version of Encyclopedia Britannica, anyone can provide updates (compare with lightweight nodes), which are then approved by trusted parties who have earned moderator rights once they have gained the trust and confidence of the community (full nodes). Access is free, and update is often in near-real time, with great accuracy due to economies of agglomeration. The benefits of decentralized aggregation of knowledge over Encyclopedia Britannica, which was last printed in 2010 after 242 years of uninterrupted annual publication, are clear.



Benefits of systems predicated on blockchain:

- **Asset security:** Translucent, immutable and permanent record imparts confidence in the provenance of value being transacted and enhances fraud detection.
- **Trusted emissary:** Third party risk is reduced or eliminated as trust is distributed over the network, rather than centralised in one potentially fallible 'single point of failure'.
- **Quick to update:** Processing and transaction times are reduced with many incentivised actors; consider the Wikipedia example.
- **'Permanent uptime':** Blockchain architecture's reliance on distribution means that permanent unassailable up-time is achievable.
- **Borderless:** Being network-based and without centralisation, blockchain architectures are virtually unimpeded by borders.
- **Incorruptible:** Sharing multiple copies which are synchronously updated acts as a constant backup system for the entire ledger.

## Understanding Shared Ledgers – Levels and Layers

### Ledger levels – understanding ledger permissioning

Three ledger properties are relevant: the number of copies, reader access and write access. Traditional systems have one centralized copy of the ledger; if there is more than one copy, then the ledger is said to be shared. If anyone is able to view (ledger not permissioned) and take part in the consensus mechanism (ledger not private), then we consider this an Unpermissioned Public Ledger. The obvious example is bitcoin; this ledger level has many of the drawbacks we highlighted in the bitcoin section.

Traditional ledgers are centralized networks; bitcoin is a distributed network. Sitting between these extremes are De-centralised Permissioned Ledgers. This means those who participate in the consensus mechanism are a selected (permissioned) group, creating multiple points of centralization – much like a hub and spoke model. We think about private permissioned ledgers as those in which only the owner and select consensus participants can view the ledger, and public to be where it is transparent.

**Figure 47: Understanding your ledger level and network type**

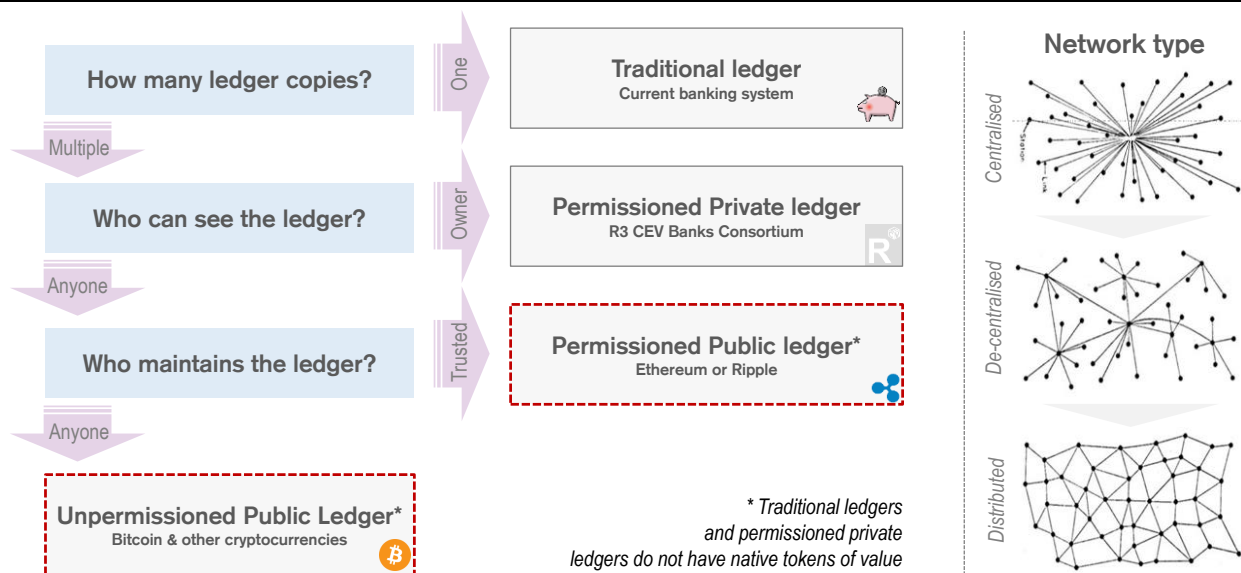

Source: Credit Suisse research based on data from Consult Hyperion and On Distributed Communications Networks by Paul Baran, 1962



There are several fundamental differences between the different types of ledger we typify above; most importantly there exists a tradeoff between cost and security. As we have examined, a distributed consensus mechanism can use demonstrations of computing power to maintain network security; this is expensive but secure. A private ledger tends to rely upon stake rather than expensive demonstration of power to enforce consensus, and therefore is a cheaper single 'source of truth', but it lacks the purity of secure 'trustless integrity' in a fully distributed architecture.

A second fundamental difference is whether assets are on-chain representations of real-world value, on-chain tokens with intrinsic value or instead any type of data.

■ **Traditional ledger**

The owner of the ledger has complete editorial power, the consensus mechanism is internal and record is not immutable. The ledger is centralized, one source of truth, and must be reconciled with other ledgers to settle transactions.

■ **Permissioned Private Ledger**

A single source of truth curated by entities 'permissioned' to instruct additions to the ledger and oversee the consensus-forming process. Incentives are generally off-chain and curators tend to have a stake in the integrity of the ledger.

■ **Permissioned Public Ledger**

As above, only permissioned stakeholders may participate in the consensus mechanism, but anyone may view and transact upon the ledger, resulting in greater transparency and accountability.

■ **Unpermissioned Public Ledger**

'Double permissionless': anyone can use this sort of ledger, and its integrity may be maintained by anyone, as long they meet certain criteria and follow certain rules. Participation in maintenance is incentivized by tokens native to the ledger.

This ledger is entirely distributed, represents a single source of truth and has 'entirely trustless integrity'.

**Figure 48: Leveling the ledgers**

Ledger	Mechanics							Function		
	Level	Copies	Readers	Writers	Incentive	Token	Cost	Security	Centralisation	
Traditional	Centralised 	One 	One 	One 	-	Off-ledger 	Average 	Worst 	Worst 	
Permissioned Private	De-centralised 	Multiple 	Multiple 	Multiple 	Stake 	Off-ledger 	Best 	Average 	Average 	
Permissioned Public	De-centralised 	Multiple 	Unlimited 	Multiple 	Stake 	On-ledger 	Best 	Average 	Average 	
Unpermissioned Public	Distributed 	Unlimited 	Unlimited 	Unlimited 	Rewards 	On-ledger 	Worst 	Best 	Best 	

Source: Credit Suisse Research; On Distributed Communications Networks by Paul Baran, 1962

**Ledger layers – understanding ledger functionality**

Once we have understood the level of ledger, we like to use Consult Hyperion's model of ledger building blocks to understand the functionality layer.

**Figure 49: Adaption of Consult Hyperion's 4x4 SLT model**

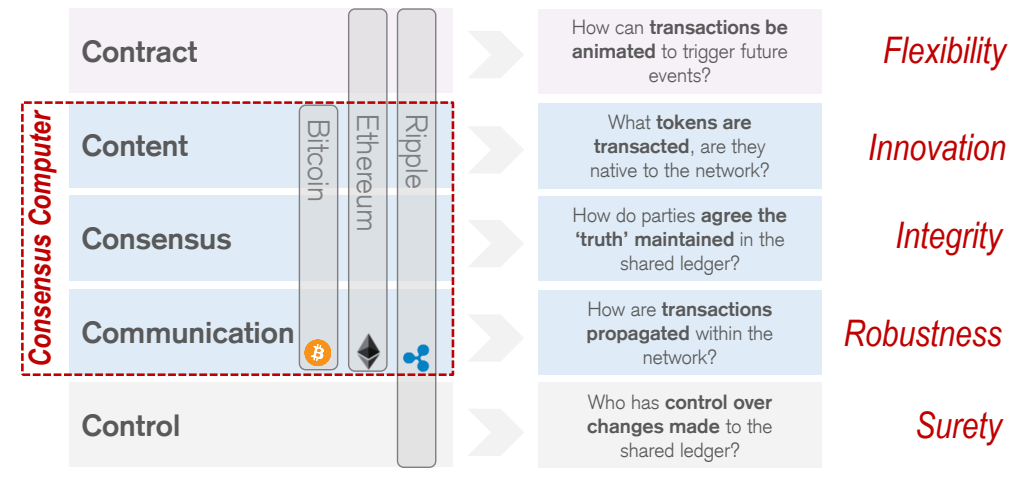

Source: Consult Hyperion, Credit Suisse research

Different functionality can be achieved depending on the levels covered, and the choices made in how the levels are approached.

While the control layer denotes the permissioning of the chain, the Content, Consensus and Communication layers are fundamental components of any consensus driven shared ledger – bitcoin, for instance, has only these three layers. Each can be flexed to achieve different objectives, for example, using Proof of Work, Proof of Stake or a voting mechanism to establish consensus, or choosing the token value to be representative of extrinsic value, to have intrinsic value, or simply to be information.

One step beyond is to animate transactions, for example by embedding contractual logic to autonomously execute terms. Below we look at possible extensions of blockchain technology in the contract layer:

■ **Smart contracts**

Smart contracts enable distribution not only of the ledger, but also of logic. Transactions are animated by the embedding of contractual logic such that execution is autonomous. Eris, a smart contract platform provider, describes them as *'blockchain housed scripts which represent unilateral promises to provide a determinate computation based on transactions which are sent to the script'*. Think of if-then statements, which execute automatically once conditions are triggered, and are recorded on a blockchain.

Obligations codified by smart contracts are easily replicable, and have the 'on-block' benefit of security, verifiability, translucency and immutability. Potential uses include anything from the simple administering of who wins or loses a bet, to the more complex payment streams of derivative transactions, mortgage payments, collateralised loans or even self-executing wills.

### ■ **Smart property**

Smart contracts offer a distributed network of rules that can keep up with increasing levels of automation. It is easy to imagine how a mortgage smart contract would work if the loan was issued in, and repayments denominated in, an on-chain token of value, for example: bitcoin.

However in the real-world, people own and transact in real-world, tangible, off-chain assets. The potential for smart contracts to interact with tangible real-world assets gives rise to the concept of smart property. A classic example envisioned by Nick Szabo in 1994<sup>2</sup> was of a leased car, should the lease be recorded as a smart-contract on the blockchain, and the car linked to the chain, if a lease payment were missed the contract could automatically revoke the digital right to use of the car.

### ■ **Proof of Existence**

The immutability and consensus properties of blockchains lend themselves to notarization of data. The content level is therefore neither intrinsic nor extrinsic units of value, but instead information which when recorded on a chain becomes time-stamped and in effect, notarised.

Implications here are potentially important as a method of authentication and certification of documents. Start-up 'Stampery' offers a bitcoin blockchain-based service which in theory proves the existence, integrity and ownership of any document, file or email with irrefutable proof. The potential extends beyond documents to proof of origin, proof of identity, authenticity and provenance.

---

<sup>2</sup> Nick Szabo. (1996) Smart Contracts: Building Blocks for Digital Markets. Extropy #16

## Challenges facing blockchain

The buzz surrounding blockchain has been compared to the excitement accompanying the internet in the 1980s. Some proponents describe blockchain technology as a solve-all panacea – innovation thought leader Don Tapscott has said he thinks the technology will 'completely reinvent some of the institutions in society that we have used to build the modern capital system, the corporation being the first among them...' (DLD Conference 16, 19<sup>th</sup> Jan 2016).

### Figure 50: From Silicon Valley titans to the Bank of England, blockchain buzz appears universal...

'Bitcoin is a remarkable cryptographic achievement and the ability to create something that is not duplicate in the digital world has enormous value'  
– **Eric Schmidt, former CEO of Google**

'I'm reasonably confident... that the blockchain will change a great deal of financial practice and exchange... 40 years from now blockchain and all that followed from it will figure more prominently in that story than bitcoin.'  
– **Larry Summers, President of Harvard University**

'The potential impact of the distributed ledger may be much broader than on payment systems alone. The majority of financial assets – such as loans, bonds, stocks and derivatives – now exist only in electronic form, meaning that the financial system itself is already simply a set of digital records.'  
– **Bank of England**

'[Cryptocurrencies] may hold long-term promise, particularly if the innovations promote a faster, more secure and more efficient payment system'  
– **Ben Bernanke, former chairman of the Federal Reserve**

'The consequences of this breakthrough are hard to overstate'  
– **Marc Andreessen, inventor of the first web browser**

Source: See footnotes<sup>3, 4, 5, 6, 7</sup> Credit Suisse research

However, although we recognize the potential of blockchain architecture to disrupt in certain ways, we question the panacea thinking. Instead we think there are several key challenges to widespread implementation of blockchain-based solutions:

#### 1. Security vs Cost trade-off

Unpermissioned public blockchains like that which underlie the bitcoin system can be seen as the 'purest' form of blockchain. Full distribution and permissionless participation mean authority is fully devolved; it is in theory infeasibly costly for any one entity to gain even a semblance of control. This truly trustless architecture means high security, but as we see with bitcoin, such security comes at a price not dissimilar from the transaction costs we see in legacy systems.

<sup>3</sup> Michael Miller (2015) The Ultimate Guide to Bitcoin, p.6

<sup>4</sup> While speaking at Consensus 2016 conference: Making Blockchain Real

<sup>5</sup> Bank of England Quarterly Bulletin 2014 Q3, click [here](http://www.bankofengland.co.uk/publications/Documents/quarterlybulletin/2014/qb14q3digitalcurrenciesbitcoin1.pdf) <http://www.bankofengland.co.uk/publications/Documents/quarterlybulletin/2014/qb14q3digitalcurrenciesbitcoin1.pdf>

<sup>6</sup> Department of Homeland Security's (DHS) Responses to Chairman Carper and Senator Coburn's August 12, 2013 Letter Regarding Virtual Currencies. Click [here](#)

<sup>7</sup> Why Bitcoin Matters, New York Times, Jan 21<sup>st</sup> 2014, click [here](#)

On the other hand, permissioned ledgers can be much cheaper as the consensus mechanism doesn't require participants to engage in resource intensive proof of work type activities to prove their trustworthiness; instead only trustworthy actors are permitted to be involved in determining consensus and adding to the chain. However, as we increase our trust in permissioned authors, we lose the distribution which ensures high levels of ledger integrity. The obvious question is also – who decides on who is trustworthy enough to be permissioned?

**Figure 51: Cost vs Security tradeoff of blockchain types**

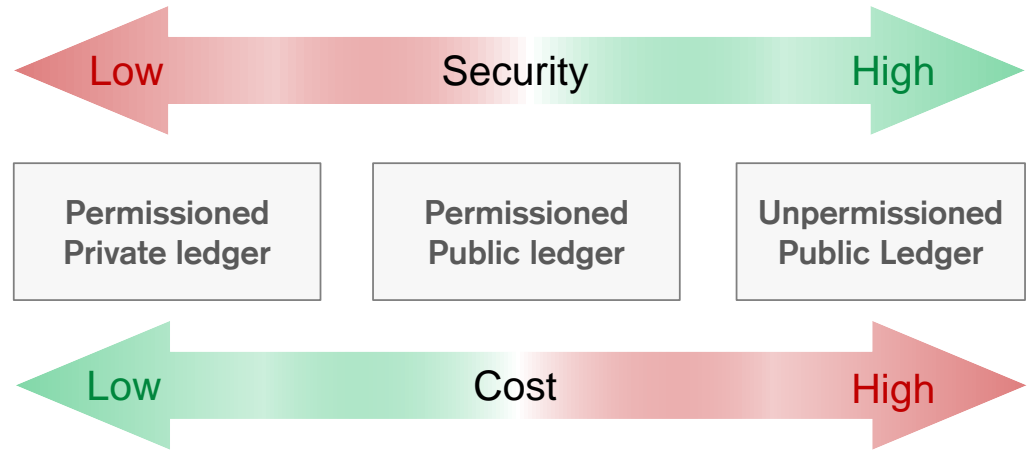

Source: Credit Suisse research

Some compare permissioned blockchains to the walled garden 'intranets' like AOL in the early 1990s; the argument goes that the *internet*, not *intranets* prevailed. Permissioned blockchains, they say, are 'relational databases mixed with snake oil' (American Banker, November 2015).

Others cite the prohibitive costs of unpermissioned chains, and make a case that different applications require different solutions. For example, 11 members of the R3 consortium comprising over 50 banks tested a private blockchain solution between the 11<sup>th</sup>-15<sup>th</sup> of January this year, successfully exchanging tokens representing a theoretical asset and achieving instantaneous verification by all nodes (WSJ, 11<sup>th</sup> Jan 2016).

**2. Do you actually need a blockchain?**

The old adage 'if it ain't broke, don't fix it,' comes to mind when assessing the applicability of some proposed blockchain use-cases. The below schematic shows that for a blockchain to be relevant, you must 1) require a database, 2) need shared write access, 3) have unknown writers whose interests are not unified, and 4) not trust a third party to maintain the integrity of the data. To summarise, some proposed blockchain use-cases appear to be solutions in search of problems.

This means that blockchains may not always be necessary; for certain applications a regular relational SQL database will be as, if not even more, appropriate. Multichain (an open platform for building blockchains) explain that these products (Oracle or MySQL) have the benefit of some of the most tire kicked, debugged and optimized code on the planet, and they can process many thousands of transactions per second with relative ease. Blockchains are, in contrast, nascent in their development.

**Figure 52: Do you really need a blockchain?**

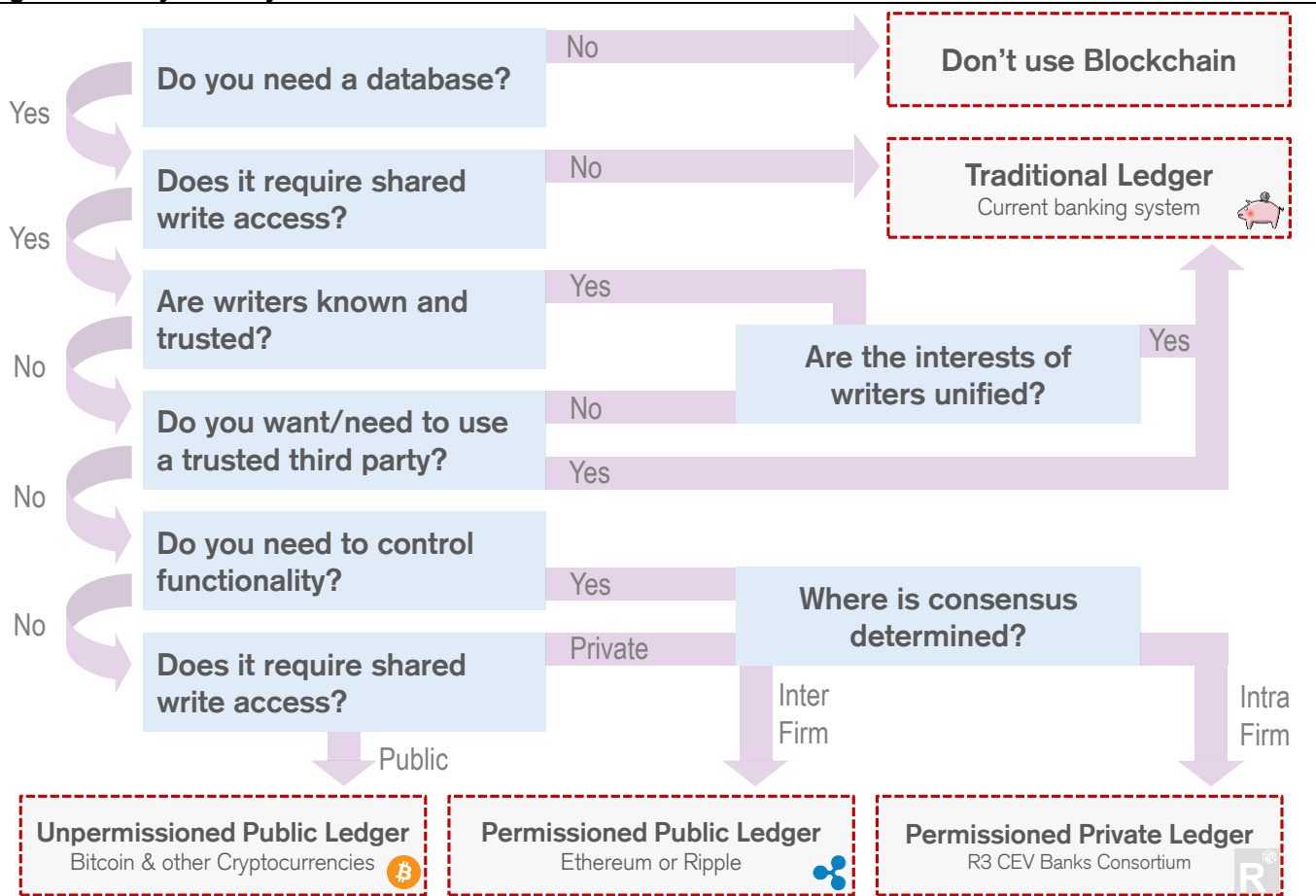

Source: Credit Suisse research, adapted from Gideon Greenspan ([here](#)) and Bart Suichies ([here](#))

**3. Critical mass essential**

Blockchain-based solutions intrinsically rely upon multiple users, particularly at the authoring level. Below we see how bitcoin follows a rough application of Metcalfe's law, which says that the value of a network is proportional to the number of connections in the network squared. We think this carries to other blockchain solutions, and believe that widespread adoption is essential for the positive network effect of blockchain to be truly harnessed – a single entity using blockchain is analogous, in our view, to a centralized database.

Michael Bodson, the president and CEO of DTCC, reflected these concerns when he recently remarked that *'to realize the potential of distributed ledger technology in a responsible manner and to avoid a disconnected maze of siloed solutions, the industry must work together in a coordinated fashion'* (DTCC, 25<sup>th</sup> Jan, 2016). Euroclear echoed the sentiment in a joint report with Oliver Wyman, writing *'the industry needs to take a collective view on the potential of the technology...'* (Feb 2016).

We see clear threats to achieving critical mass: 1) fragmentation of platforms, and 2) institutional and social inertia to transition to and/or agree on a platform. To achieve critical mass, firstly a single opensource platform would need be built upon by all developers. We see projects like Ethereum as attempting to assume this mantle. Secondly industry consortia would need to unanimously agree on chain projects. Again we see R3CEV as instrumental to establishing the consensus necessary to implement a consensus ledger.

**Figure 53: The 'market cap' of bitcoin has been proportional to the transaction value squared...**

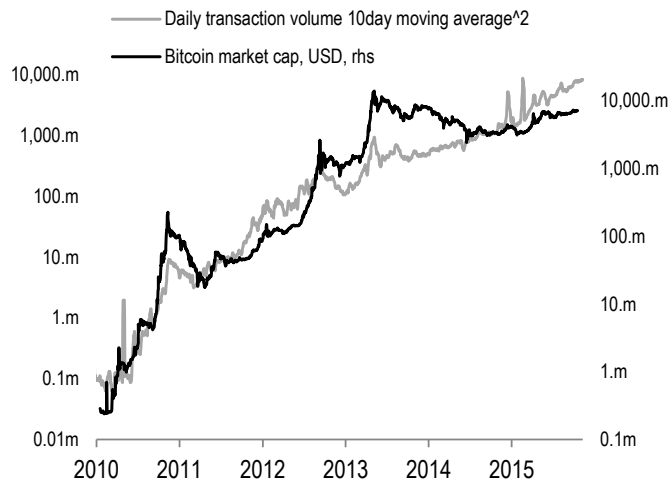

Source: bitcoin.info, Credit Suisse research

**Figure 54: ... following Metcalfe's law: network value is equal to the number of connected users^2**

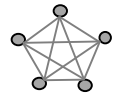
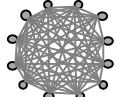
p			
Metcalfe's Law	Peers	Connections	Value
	2	1	4
	5	10	25
	12	66	144

Source: Credit Suisse research

**4. What you get out is only as good as what you put in...**

We are guilty of describing the information stored on shared ledgers as a 'single source of truth' many times in this note. In reality there is no guarantee of 'truth' just because information is on a blockchain.

In reality the 'truth level' of on-chain information is only as good as barriers employed to (1) ensure the quality of data being added is high, and (2) ensure the quality of node permissioned to add to the chain is high. If we think about bitcoin, veracity of information added to the chain is ensured by strict rules in terms of data syntax for transactions to be acceptable, and by making it very hard to write the chain – the proof of work burden.

**5. More entry points make a blockchain system more hackable...**

The hackable 'surface area' of a distributed network increases with each node added. The most secure databases, for example those run by share-registrar Equiniti, are air-gapped. This means the secure computer network is physically isolated from unsecured networks like the internet, and therefore in theory extremely secure from cyber-attack.

While we do think there are sure to be data-security solutions in a blockchain world, for example each node's copy of the blockchain could be air-gapped – the 'mempool' equivalent, data waiting to be added to the next block, must surely be accessible over a network as it is being shared with other nodes. Of even more concern, should a malicious individual gain access to a comprehensive banking blockchain, the aggregate data available to steal could be equivalent to hacking every one, of every bank's databases simultaneously.

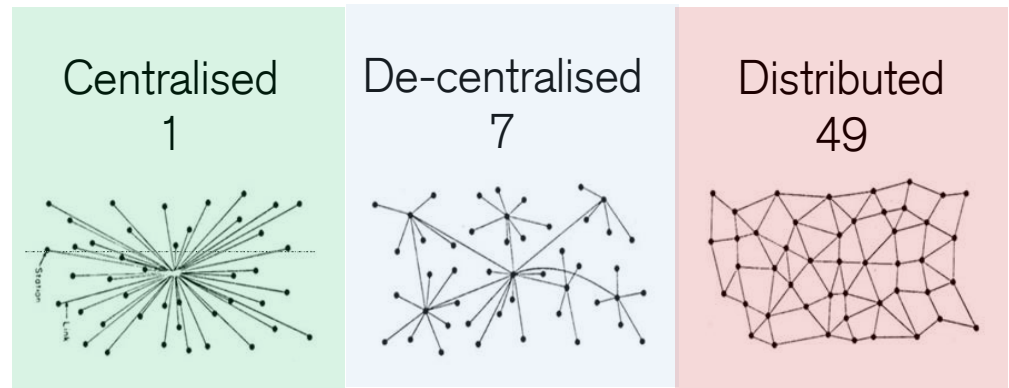

**Figure 55: Hackable surface area increases with distribution**

Source: On Distributed Communications Networks, Paul Baran; Credit Suisse research

## 6. You have to see it to believe it...

Although it may appear that blockchain data is by nature encrypted, this is not actually the case. On the bitcoin blockchain identity is encrypted, but transactional data is not. The key reason for this is that to validate additions to the chain, nodes must have visibility over what they are validating.

This may not be an issue on private chains where we trust permissioned nodes to handle sensitive data; however the limited anonymity/privacy this mandates on public chains may be a barrier to adoption. Antony Lewis, a blockchain consultant to financial institutions, notes that cryptographic solutions known as zero-knowledge proofs are emerging, potentially enabling validation of data without visibility over the underlying data itself, but these remain very nascent (Coindesk, July 22<sup>nd</sup> 2016).

## 7. How is the identity problem solved?

We think many blockchain use-cases rest upon the assumption that identity can be reliably determined and managed on-chain, thereby enabling disintermediation of the trusted third party identity management function. However, as we have noted regarding bitcoin, on-chain asset ownership by virtue of private key knowledge essentially makes all on-chain assets bearer instruments. The issue with bearer instruments is you can lose them; cash being the most salient example.

To circumvent this issue we believe it is therefore necessary to either (1) have a private key management function, or (2) solve the identity problem – perhaps achievable through biometric linked private keys. There are problems with both, however:

- Tim Swanson (Director of Market Research at R3CEV) notes that in response to the challenges of personal bearer instrument management 'the [bitcoin] ecosystem birthed facilitators (custodians) and intermediaries (depositories) where an individual no longer controls the applicable access credentials' (Swanson on ofnumbers.com, 25<sup>th</sup> March 2015). We fear that requiring a third party private key management function is contradictory to the disintermediating core principles of distributed ledgers and reduces their utility.
- Although biometrically linked private keys may provide a solution to the illusive identity issue, we are challenged to believe a database of such extraordinary power will be willingly endorsed by users and governments alike.

## 8. A forked road, the lesson of the DAO attack...

The DAO (decentralized autonomous organization) was instantiated upon the Ethereum blockchain and was the manifestation of how some – like 'Blockchain Revolution' co-author Alex Tapscott – believe that blockchain-enabled organizations have the potential to reinvent institutions of the modern capital system – particularly the corporation.

Think of the DAO as a leaderless crowd-funded crowd-funding vehicle: DAO tokens could be purchased like shares in a PLC, and your shareholding entitled you to proportionate votes in the financial actions and proportionate participation in the financial returns of the DAO. The entire organization was run as a web of smart contracts. TechCrunch saw the DAO as offering '*complete transparency, total shareholder control, unprecedented flexibility and autonomous governance*' in May 2016, as of that month the vehicle's Ether (Ethereum on-chain token) value was US\$150m.

In June, a recursive hack exploited bugs in the DAO's smart contract code, effectively withdrawing others investments from the entity. Ultimately c.US\$50m was withdrawn by the malicious party (FT, June 17<sup>th</sup> 2016). In a recent decision the Ethereum foundation upheld the community consensus to 'hard fork' the blockchain (IB Times, 19<sup>th</sup> June 2016). This means that the chain has been 'restarted' from a block before the attack, effectively erasing any history of the attack, and all transactions and contracts following it.

Two problematic issues arise:

- Nascent code is susceptible to bugs before it is truly tire kicked, and even then, complete surety is never guaranteed. This leads us to wonder if the 'smart contract' can ever truly do away with the wet-signed, lawyer approved, paper contract.
- Hard forks are ultimately edits to the single 'source of truth'; setting the precedent for this sort of 'truth management' reduces the immutability property of all blockchains, not dissimilar to how the Cypriot deposit levy reduced confidence in many banks.

# Impact on the real economy

## When and to what extent will blockchain impact?

*“58% of surveyed executives and experts from the information and communication technology sector believe 10% of global GDP will be stored on blockchain technology by the mid-2020s.”*

- World Economic Forum, Deep Shift, September 2015

Although the potential transformative benefits of blockchain are manifold, it remains challenging to estimate the extent of its impact on the real economy at this nascent stage. The World Economic Forum surveys over 800 executives for their Technological Tipping Points report; we find these aggregated expectations an interesting way of understanding the technology's potential.

The report considers blockchain as important to the sharing economy and distributed trust – one of six megatrends isolated in the report: *'The internet is driving a shift towards networks and platform-based social and economic models. Assets can be shared, creating not just new efficiencies but also whole new business models and opportunities for social self-organization. The blockchain, an emerging technology, replaces the need for third-party institutions to provide trust for financial, contract and voting activities.'*

### Figure 56: Respondents expect a government to collect tax on-chain by 2023, but don't expect 10% of Global GDP to be 'on block' until 2027

Figure 1: Average Year Each Tipping Point Is Expected to Occur <sup>1</sup>

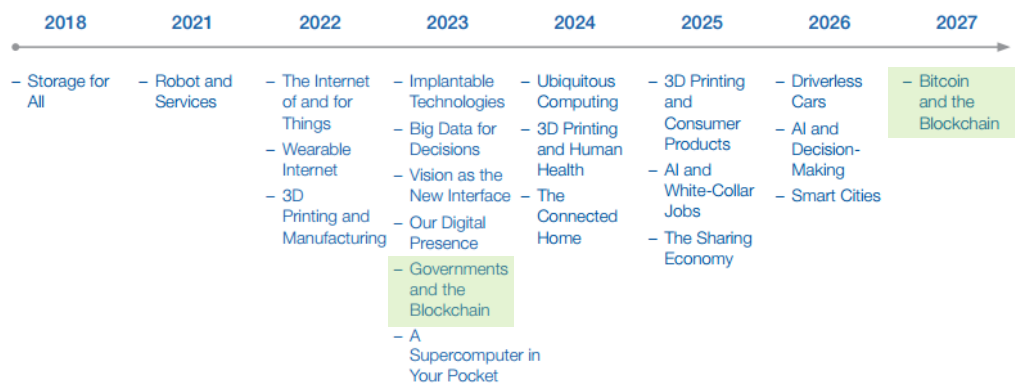

Source: World Economic Forum, Credit Suisse Research

The report derives a 'tipping point' timeline from survey responses that indicate the year in which they think the event is most likely to first occur. However, it is worth noting that 58% of respondents expect 10% of GDP to be stored on the blockchain by the mid-2020s, and 73% of people expect tax to be first collected on-chain before 2025.

We note that currently the 672 largest cryptocurrencies tracked by coinmarketcap.com have a total market value of nearly US\$13bn, which is 0.017% of 2015 global GDP. Were the remaining trillions of dollars of value to migrate on-block by 2025 it would be a phenomenal shift, but perhaps not incomparable to the migration of information online in the 1990s. Below we show 2014 Global Gross Value Added and estimate what extent different industries' value added would need to be 'blockchain-able' to add some additional color to the World Economic Forum's survey.

**Figure 57: Adoption scenarios for Global Gross Value Added migration to blockchain**

Gross value added, Current prices OECD, \$m	United States	European Union	Japan	United Kingdom	Australia	Mexico	Switzerland	Sweden	Poland	Norway	Denmark	Chile	Czech Republic	Hungary	Iceland	Total	Blockchain'able' portion, penetration rate:		
																	Low	Medium	High
Agriculture, forestry and fishing	223,859	263,155	53,509	18,194	33,861	40,419	5,114	6,965	14,194	7,494	2,859	8,820	5,022	5,194	1,247	689,913			
Mining and quarrying	436,008	117,115	3,233	42,334	98,047	87,751	842	2,647	8,593	99,058	4,203	28,870	1,522	267	20	930,522			
Manufacturing	2,068,080	2,571,458	851,347	283,035	92,456	217,632	128,979	82,655	89,979	34,999	37,635	27,579	49,357	27,354	2,527	6,565,089			
Electricity, gas, steam and air conditioning supply	260,644	312,942	90,955	39,911	35,609	19,741	-	12,155	16,201	9,130	3,980	5,786	7,153	2,370	835	817,462			
Water supply, sewerage, waste management	41,866	157,969	-	27,724	-	5,426	-	3,410	6,122	2,645	2,042	-	2,085	1,211	207	250,758			
Construction	664,001	889,622	279,195	165,742	119,666	90,583	36,271	30,454	35,952	25,903	11,485	19,503	10,368	5,065	1,119	2,384,983			
Wholesale and retail trade, repair of motor vehicles	1,675,586	1,822,123	647,629	286,138	123,679	205,104	97,927	54,979	88,834	32,021	30,397	22,085	19,135	11,845	1,871	5,119,412	12.5%	25%	50%
Transportation and storage	542,582	840,117	230,445	121,202	68,963	79,818	-	27,498	30,985	24,454	13,681	11,109	10,597	7,385	1,170	2,010,067			
Accommodation and food service activities	446,343	469,314	-	77,541	36,137	27,455	12,031	8,820	5,911	5,815	3,873	4,728	3,627	1,941	573	1,104,176	12.5%	25%	50%
Information and communication	1,035,296	810,853	251,856	164,537	38,469	28,340	-	28,442	18,877	17,123	11,869	4,113	9,134	6,023	950	2,425,953			
Financial and insurance activities	1,190,501	911,125	199,164	217,874	125,628	45,871	66,679	23,234	21,502	22,949	16,470	12,553	8,365	4,286	1,575	2,867,856	37.5%	75%	100%
Financial service activities	486,523	-	-	116,681	-	38,128	38,125	-	16,486	-	-	-	6,458	3,258	1,313	707,053			
Insurance, reinsurance and pension funding	460,938	-	-	67,217	-	4,250	28,554	-	2,977	-	-	-	1,245	353	173	565,788			
Auxiliary activities	243,039	-	-	33,976	-	3,493	-	-	2,039	-	-	-	662	675	89	284,056			
Real estate activities	2,076,838	1,845,942	531,750	299,340	172,100	137,797	-	42,887	25,187	29,844	26,377	-	15,374	9,209	1,978	5,214,707	12.5%	25%	50%
Administrative and support service activities	659,756	698,695	-	126,770	39,659	45,383	-	17,385	10,595	12,395	8,737	-	3,305	3,855	592	1,627,225	25%	50%	75%
Rental and leasing activities	181,934	-	-	25,191	-	5,501	-	-	2,060	-	-	-	876	900	251	216,812			
Employment activities	-	-	-	27,541	-	29,347	-	-	2,684	-	-	-	142	868	6	60,688			
Public admin and defence, compulsory social security	1,500,551	1,081,252	280,902	137,214	76,458	53,626	73,459	25,067	27,285	26,934	14,152	11,965	11,598	9,748	1,092	3,331,409	10%	20%	50%
Education	935,475	878,251	-	164,898	69,537	52,918	3,758	28,397	23,208	21,688	16,734	12,858	7,959	5,417	1,252	2,222,458			
Human health and social work activities	1,225,883	-	-	180,380	95,853	28,699	51,911	56,152	21,557	45,572	28,015	10,698	7,881	5,070	1,608	1,759,387			
Arts, entertainment and recreation	160,936	229,567	-	42,087	12,018	5,595	-	6,981	3,408	4,217	4,020	6,975	1,772	1,527	315	479,531			
<b>Total activity</b>	<b>32,083,680</b>	<b>13,899,501</b>	<b>4,546,774</b>	<b>4,584,493</b>	<b>1,517,282</b>	<b>2,524,803</b>	<b>548,763</b>	<b>496,655</b>	<b>842,871</b>	<b>564,014</b>	<b>279,354</b>	<b>222,695</b>	<b>347,831</b>	<b>213,368</b>	<b>33,701</b>	<b>62,705,786</b>	<b>5.2%</b>	<b>10.4%</b>	<b>18.3%</b>

Source: OECD, Credit Suisse estimates

## How will blockchain impact?

*“Evangelists say it will change everything and [the] sceptics ... say it will change nothing. The answer will surely be somewhere in between, but to which of these two extremes the outcome skews towards and when it will do so is the subject of much speculation.”*

- Shaun Drummond, SMH, March 28th, 2016

We think about the potential impact of blockchain in three simple ways:

- **Opportunities:** Where blockchain offers the potential to re-engineer, rationalize and increase the efficiency of legacy systems and technology, thereby removing costs, increasing overall firm-level efficiency and perhaps offering novel revenue streams.
- **Traps:** Where blockchain may disintermediate incumbents, either through rendering obsolete their current services or by encouraging vertical integration.
- **Growth:** Where as yet unimagined potential – applications, implications and revenue opportunities – arise from applications built upon blockchain.

**Figure 58: Main benefits of blockchain technology – % of survey respondents**

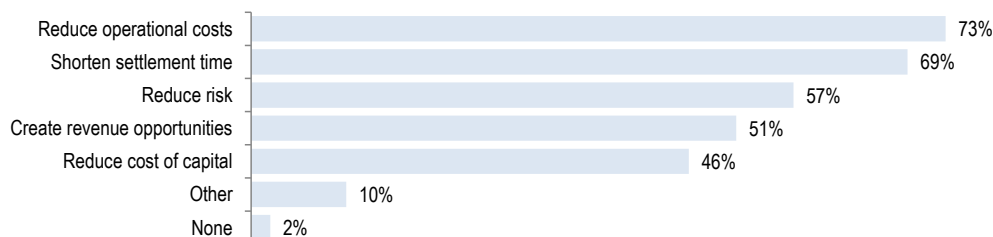

Source: Greenwich Associates 2016 Blockchain Adoption Study, Credit Suisse research

## Where will blockchain impact?

Most obviously impacted are (1) industries in the business of selling trust, and (2) industries which currently experience great friction.

Several surveys have been undertaken which give an indication as to which industries consensus expects blockchain to impact the most. Undeniably foremost in people's minds is Financial Services, in which Payments and Capital Markets stand out.

**Figure 59: Blockchain thought leaders believe blockchain will most impact Financial Services**

Which areas do you think blockchain technology will have the greatest impact in?

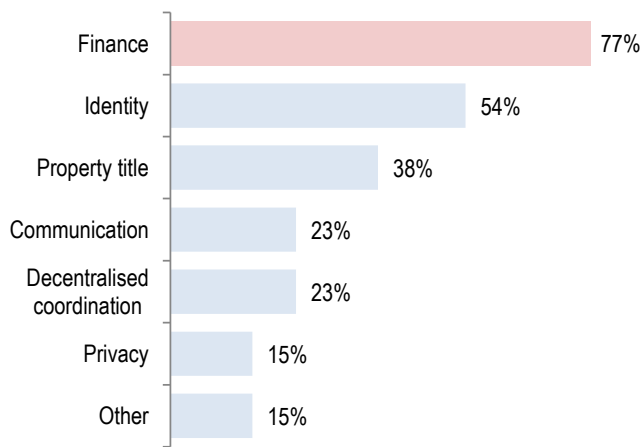

Source: Bitcoin and Blockchain Thought Leaders Annual Survey, Credit Suisse Research

**Figure 60: Within Financial Services, Payments and Capital markets appear most disruptable**

Most promising use cases to deliver change in Financial Services:

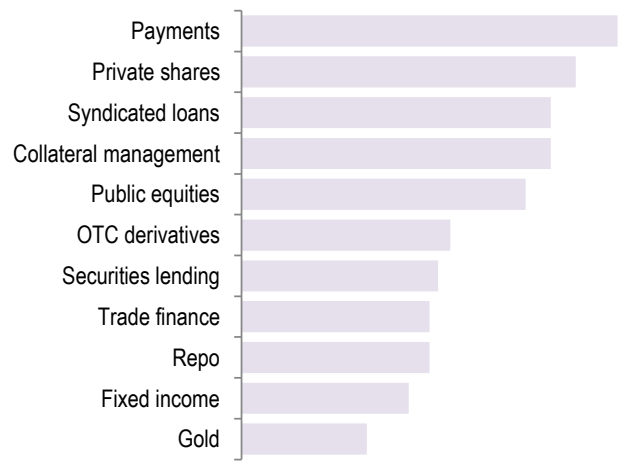

Source: Greenwich Associates 2016 Blockchain Adoption Study, Credit Suisse Research

In the following sections we analyse the potential of blockchain in the industries in which investors are most concerned:

- **Payments:** Merchant Acquirers, Card issuers and Financial Payments Processors,
- **Capital Markets:** Custodians, Exchanges and Registrars,
- **Financial Services:** Retail Banks, Investment Banks and Credit Bureaus
- **Media:** Music, Ad-funded TV, Pay TV, Digital Video and Publishing

For each we have written a 'use-case' which details how we think blockchain architecture could be implemented in the sector. We have then asked our global analysts to respond to the use-cases by answering three key questions:

1. What is the market opportunity should the use-case occur?
2. Who would win and who would lose under this eventuality?
3. How likely is this to happen?

To complete each section, we have selected specific names which our analysts deem to appear most exposed to blockchain within the sector, either positively or negatively.

**Figure 61: Exchanges, Merchant acquirers and Credit Bureau have low expectations on Credit Suisse HOLT®, but seem undisturbed by blockchain**

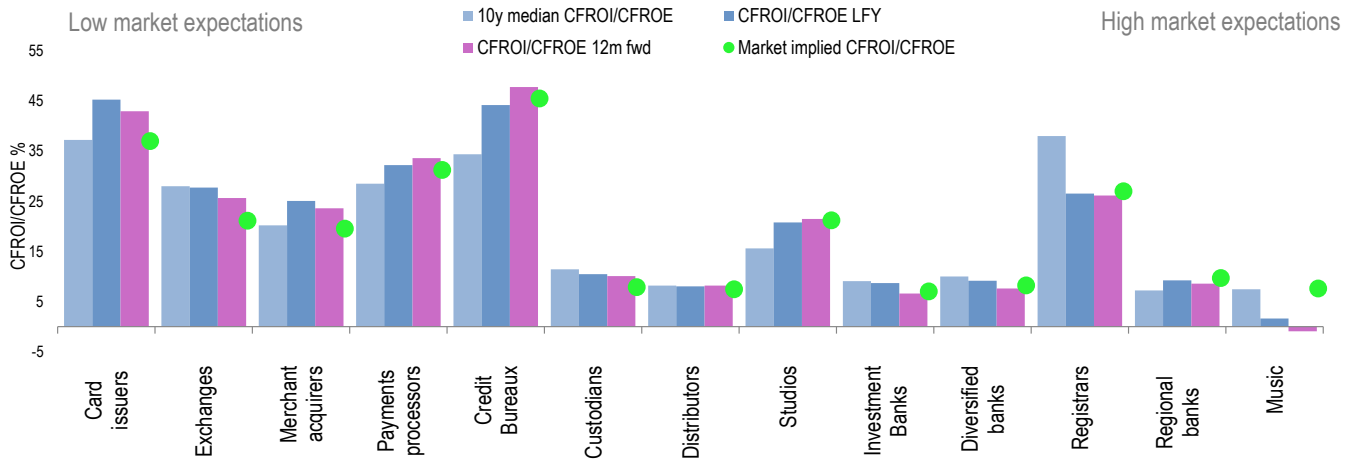

Source: Credit Suisse HOLT, Credit Suisse research

Exchanges, merchant acquirers, payments processors and credit bureaus appear to have relatively undemanding market expectations in HOLT, whereas registrars and banks appear to have higher expectations priced in.

**Figure 62: On a stock-specific level, the majority of the names we isolate in this report look relatively attractive on HOLT's investment styles scorecard**

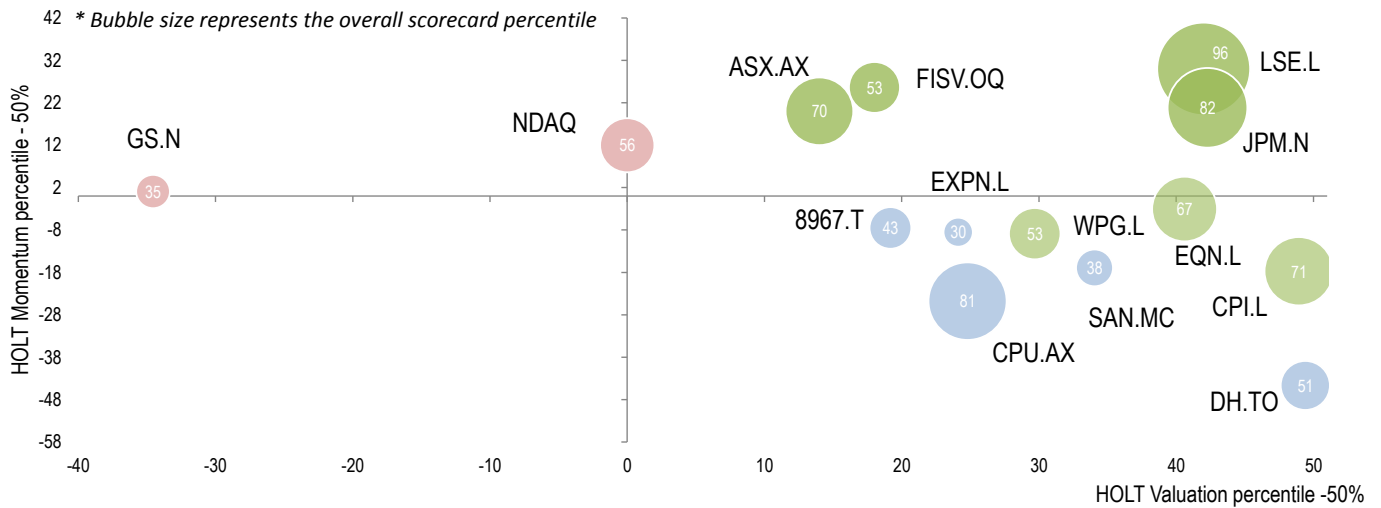

Source: Credit Suisse HOLT, Credit Suisse research

# Payments

## Use case

**Research Analysts**

**Charles Brennan CFA**

44 20 7883 4705

charles.brennan@credit-suisse.com

### Market size – large

The payments industry is both very large and very well established; these dynamics make the space appear ripe for new entrants to attempt to disrupt the status quo. Contrarily, our analysis suggests blockchain is unlikely to be a major disrupter and we continue to believe the sector is capable of sustainable multi-year growth.

BCG<sup>8</sup> estimates global payment revenues to be c.\$1.1trn. However this very broad definition includes all payment revenues, including interchange fees, merchant acquiring fees, cross border fees in addition to spread income on current account balances.

If we focus on merchant acquiring revenues, then The Nilson Report (issues #1087 and #1082) suggests the top c.120 acquirers in the US and Europe process a combined \$8trn of transaction value. Based off an average net take<sup>9</sup> of 0.6%, we think this implies a merchant acquiring opportunity well in excess of \$55bn.

These statistics demonstrate the sheer scale of the industry and highlight the size of market opportunity as perceived by potential new entrants.

**Figure 63: Global merchant acquiring transaction value from top acquirers in the US and Europe**

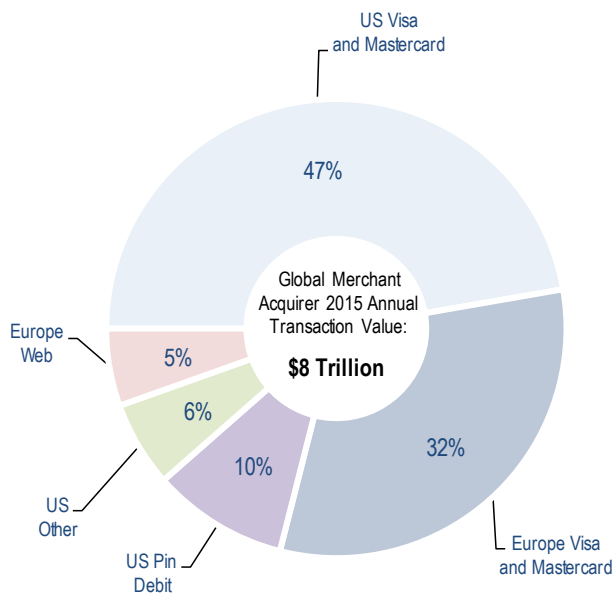

Source: The Nilson report, Credit Suisse estimates

**Figure 64: In addition to the market's size, growth has been sustained and healthy**

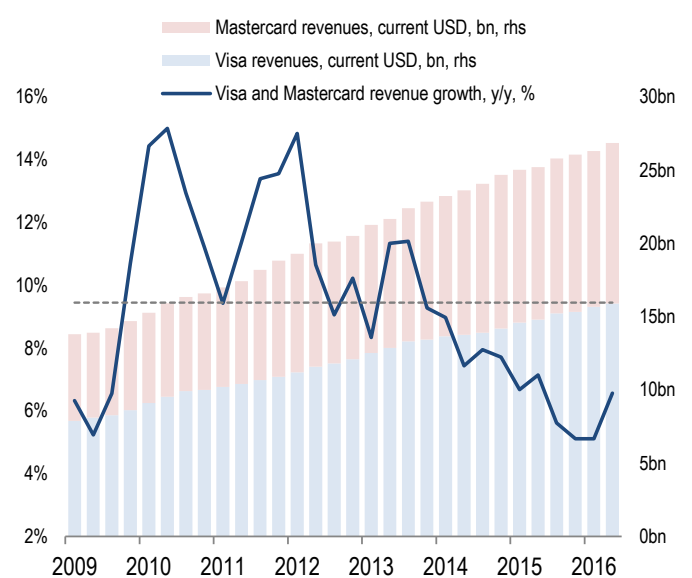

Source: Thomson Reuters Datastream, Credit Suisse estimates

<sup>8</sup> <https://www.bcgperspectives.com/content/articles/financial-institutions-digital-economy-global-payments-2015-listening-customer-voice/>

<sup>9</sup> We calculate an average from FY15 metrics from Worldpay, Wirecard, Paysafe, Heartland and Global Payments



**Market structure – perceived as highly frictional**

The payments market is not only large, but the current "four-party" has its origins in the 1960's; Figure 65 highlights this. We think the age of the current market structure (wrongly) gives aspirants the impression that it is overdue an overhaul. Specifically, a four-party system adds three extra players – layers of friction – between the merchant and the consumer, giving rise to criticism that transaction costs are too high.

**Figure 65: Evolution of the four-party system**

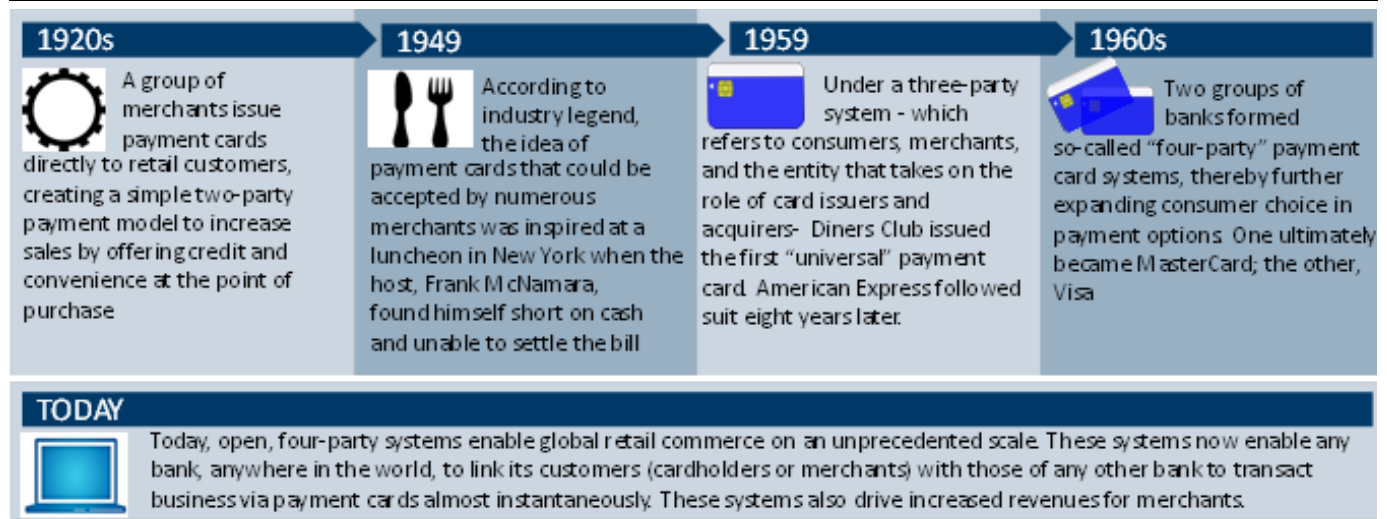

Source: Mastercard

This four-party system includes the below players:

1. A merchant
2. A consumer
3. A card issuing firm
4. A card network

The role of each is shown in Figure 66. This diagram clearly shows that while a cash transaction only involves a consumer and a merchant, a non-cash transaction also involves an acquirer, card network and a card issuer.

**Figure 66: A four-party system as it exists in the card industry**

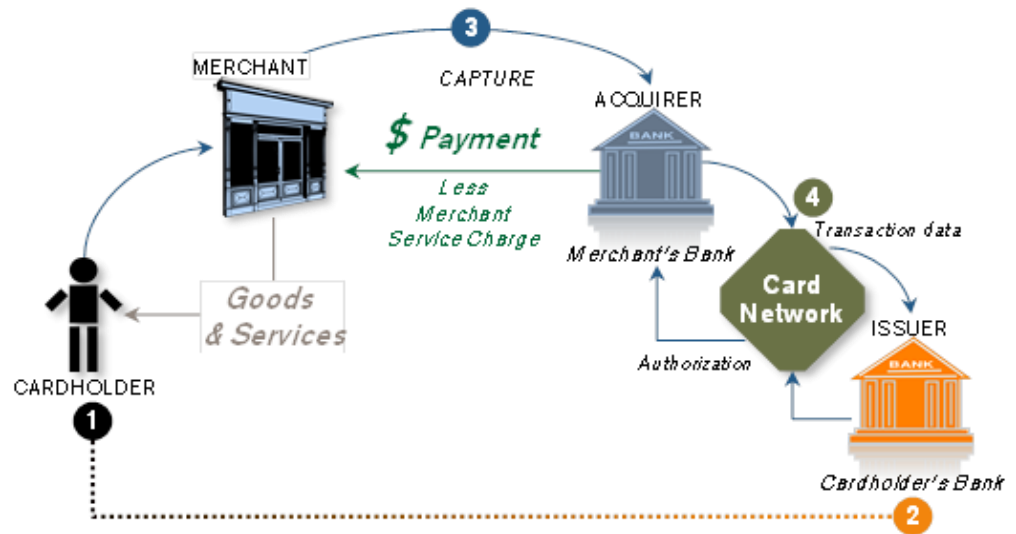

Source: Credit Suisse research

The acquirer, card network and card issuer all charge fees such that the typical cost to the merchant in the US is around 2%. At this juncture its worth remembering that the total cost of running the bitcoin blockchain is slightly cheaper, but not by many orders of magnitude at c.1.3%.

**Figure 67: The breakdown of the merchant service charge**

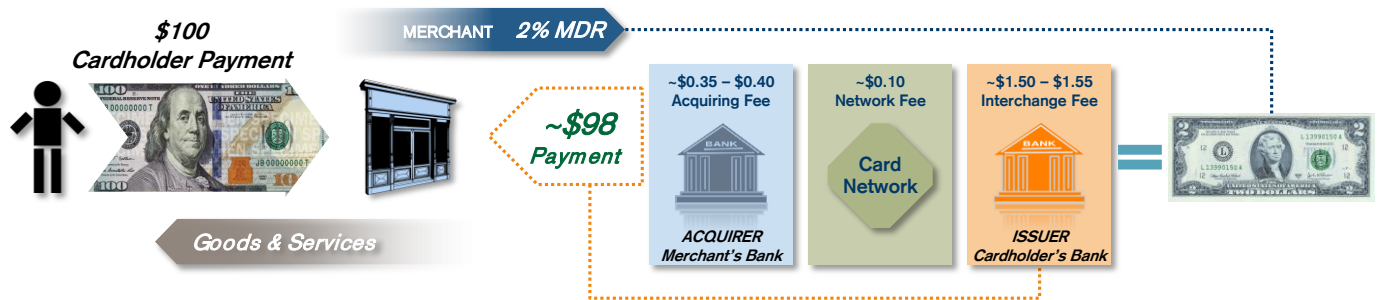

Source: Credit Suisse research

In light of the complexity and cost of the current payments infrastructure, we understand investors are wary of potential disruption. We see two possible scenarios for blockchain technology to disrupt payments, but on balance we view the existential threat to the industry as modest.

- Bitcoin gains traction as a payment method, and
- Blockchain technology is used in an attempt to disintermediate the parties that sit between the consumer and merchant.

## Use Case #1

### Bitcoin to gain traction

The first scenario is that bitcoin gains traction, replacing traditional Visa/Mastercard card transactions. This is an example of a double permissionless ledger, ie anyone can view the data and anyone can contribute to the consensus as long as they meet certain criteria.

**Figure 68: An unpermissioned ledger allows virtually anyone to participate and form the consensus**

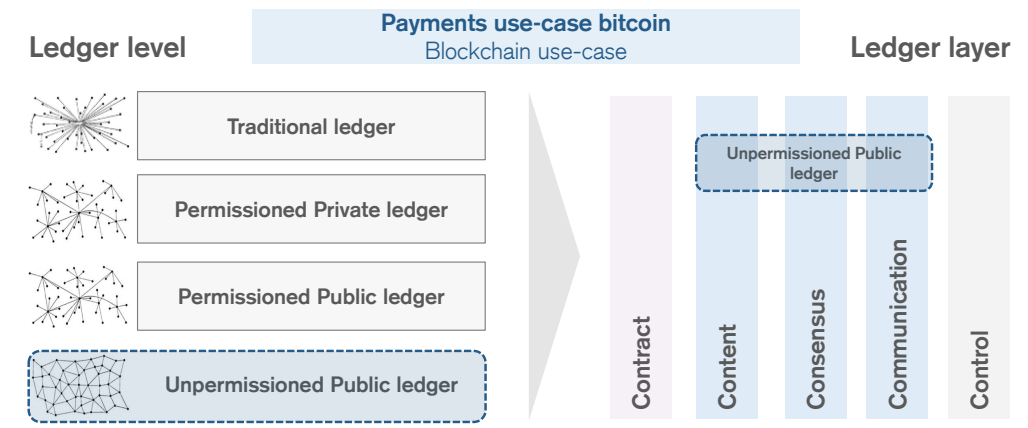

Source: Credit Suisse research based on data from Consult Hyperion and On Distributed Communications Networks by Paul Baran, 1962

Bitcoin.org<sup>10</sup> indicates the advantages of this system are:

- **Payment freedom** – It is possible to send and receive bitcoins anywhere in the world at any time. So the system is both global and fully operational 24x7.
- **Fewer risks for merchants** – Bitcoin transactions are secure, irreversible and do not contain customers' sensitive information. This protects merchants from fraud or fraudulent chargebacks.
- **Security and control** – Bitcoin users are in full control of their transactions; it is impossible for merchants to force unwanted or unnoticed charges. Bitcoin payments also contain no personal information, so there is strong protection against identity theft.
- **Transparent and neutral** – All information concerning the bitcoin money supply is available on the blockchain for anybody to use. No individual or organization can manipulate the bitcoin protocol because it is cryptographically secure, and therefore highly censorship resistant.
- **Choose your own fee** – There is no fee to receive bitcoins, and some wallets let you control how large a fee to pay when spending. Higher fees can encourage faster confirmation of transactions. While transactions have low fees, we do note this ignores the "fee" that is paid to the miners for confirming the transaction.

<sup>10</sup> <https://bitcoin.org/en/faq#what-are-the-advantages-of-bitcoin>

We believe these advantages will help bitcoin remain a durable and secure cryptocurrency, most particularly for those users that value anonymity highly. However, our detailed analysis on page 33, shows 13 major barriers to using bitcoin. While none appear insurmountable in isolation, we think they present such a meaningful challenge in aggregate that bitcoin will struggle to ever gain mainstream adoption. In our view the five most important barriers are:

- **Transaction confirmation is slow:** Transactions do not appear in the blockchain until they have been entered into a block. While transactions with fees are generally added within c.9 minutes, transactions with lower fees can take 40 plus minutes on average. Of course once recorded in the blockchain, transactions shouldn't be considered settled until they are six blocks deep – another 60 minutes.
- **Costs are hidden, not removed:** While direct transaction fees are low, the energy intensive and expensive transaction confirmation process (mining) is incentivized by the coin-reward which itself is funded by the issuance of new BTC. This reward halved from 25BTC per block to 12.5 in June, further underlining the question of how to fill the funding gap.
- **Scalability:** VisaNet is capable of processing 56,000 transactions a second and handles a daily average of 2,000 bitcoin on the other hand, given a 1MB/block size limit and performance in a recent 'stress test', is limited to around 700kb of data (three transactions) per second. To truly compete as a payment network, the bitcoin blockchain would likely need to be capable of scale comparable to large payment processors to gain mainstream relevance.
- **Irrecoverability:** It is a testament to the security of the network that should your private key be lost, the BTC associated with that address are fully unrecoverable. Equally, it is a barrier to widespread adoption. Imagine if you lost the password to your email account and could never get it back. Worse still, should anyone else possess the password, they may assume your account, and you have no control.
- **Irreversibility:** Lacking a trusted central party, there is nobody who can be appealed to or arbitrate disagreements between transacting parties. Should you, for example, send bitcoins to the wrong address, once broadcast to the network the transaction is only reversible at the discretion of the receiving party. There is no authority or mechanism for error correction.

## Use Case #2

### Blockchain technology as a disrupter

The second scenario is that blockchain technology is used as the base to replace the current payment rails – thereby disrupting the incumbent four-party card system. In this scenario, implementation of a permissioned public ledger seems the most likely solution: this is where anyone can view and transact on the ledger, but only a pre-defined set of 'permissioned' actors can participate in the consensus-forming process – we think these would be companies with a vested interest/stake in the success of the ledger.

**Figure 69: A permissioned ledger allows anyone to view, but the process of consensus forming is restricted to certain parties**

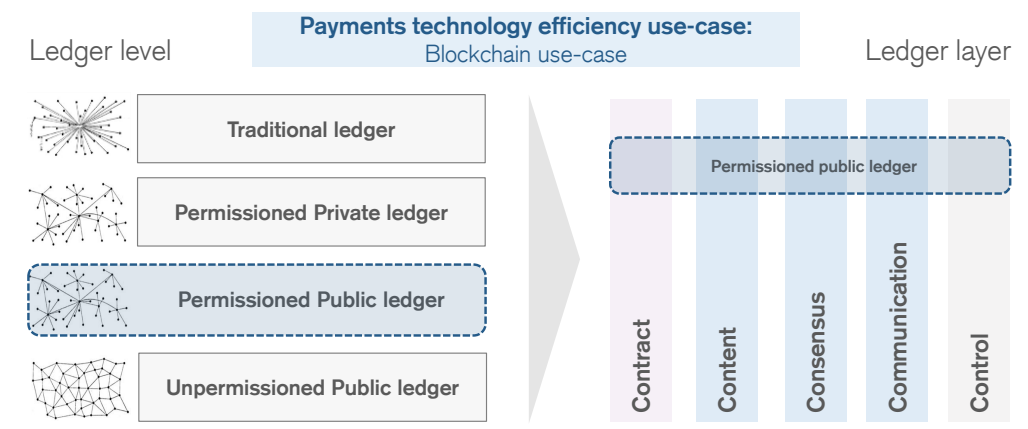

Source: Credit Suisse research based on data from Consult Hyperion and On Distributed Communications Networks by Paul Baran, 1962

One of the key benefits of a distributed ledger is that it removes the need for a central party clearing house. In some regards, we view Visa and Mastercard as fulfilling this role currently, and therefore it is possible they could be disintermediated by a new architecture predicated on blockchain technology. However, while this is technically possible, we see it practically improbable that this will disrupt the card networks.

In particular, we see the following issues that will likely stand in the way of blockchain undermining the value of card networks like Visa and Mastercard:

**Scalability questions** – The current four-party system has evolved over 50 years as a fully proven, global, scalable system that provides near instantaneous authentication of card transactions. This system is incredibly efficient and, even though transaction settlement occurs later, this is a totally seamless consumer experience. By contrast, the current bitcoin protocol is limited to c8 transactions per second, but in reality the empirical throughput is closer to 3 transactions per second. And every block is solved every 10 minutes, so authentication is not instant.

A permissioned ledger should be more efficient as the consensus parties are known, materially reducing the proof of work. However, we have seen no studies that have shown that a permissioned ledger can scale to match the throughput of Visa. SETL, which describes itself as an institutional payment and settlement infrastructure based on blockchain technology, says it has demonstrated 1bn transactions a day (FT, 12<sup>th</sup> October). However, this is still only c11k transactions a second, about 20% of the capacity of Visa, and it is not clear to us if this represents a laboratory or not real world scenario.

**Who will pay for the consensus mechanism** – Within a blockchain someone needs to oversee the integrity of the data, and help form the consensus. The compute power in a permissioned ledger is less than the bitcoin/permissionless network but companies still need compensation to fill this role. This merely replaces a card network fee with a "mining" fee and doesn't necessarily lower overall transaction costs.

**Who guarantees the consumer** – At the moment card networks and the payments processors play a very important role in providing consumer guarantees. Notably, after decades of branding, consumers generally feel confident that paying by Visa/Mastercard in any part of the world they are guaranteed they will receive the goods/services they want and are entitled to a full refund if this is not the case. The financial risk is largely borne by the acquirer but the system is controlled by the scheme rules put in place by the card networks. We think it is very difficult to see who replaces the highly trusted brands of Visa/Mastercard as this guarantee of trust.

#### **In summary**

We think it unlikely that bitcoin will gain traction as a mainstream payments network, or that blockchain will disintermediate the globally trusted brands of the card networks such as Visa and Mastercard. Similarly, we see limited risk to the payment processors like Worldpay.

## Analyst View

### Payments

#### Research Analysts

**Charles Brennan CFA**

44 20 7883 4705  
charles.brennan@credit-suisse.com

**Moshe Orenbuch**

212 538 6795  
moshe.orenbuch@credit-suisse.com

**Paul Condra**

212 325 8903  
paul.condra@credit-suisse.com

**James Ulan**

212 325 8235  
james.ulan@credit-suisse.com

**Mrinalini Bhutoria**

212 325 2691  
mrinalini.bhutoria@credit-suisse.com

#### Consumer payments - Charles Brennan

In consumer payments, we speak to a number of investors who believe the sheer scale of the industry and the complicated four-party structures make it ripe for medium term disruption. However, we do not share this view and do not see any meaningful structural risks from blockchain.

Firstly, we believe there are fundamental barriers that will prevent broad-based adoption of bitcoin. In particular, we believe some of the strengths of bitcoin actually work against mass consumer adoption. Notably, the idea that losing your private key means that any associated bitcoin are irrecoverable is possibly too secure for most consumers; after all, at least if you lose your bank card you can get a replacement. Meanwhile, not being able to reverse bitcoin if you send it to the wrong address is a material change from the consumer protections that we have come to expect from traditional card schemes.

Further, we see limited risk from blockchain as a technology to replace the existing payment rails. Looking at Visa and Mastercard, we note both are investing in blockchain initiatives:

- **Visa (V)** is involved in numerous blockchain initiatives to explore potential applications. Visa is also an investor in Chain.
- **MasterCard (MC)** is funding the growth of Everledger through its incubator. Everledger uses blockchain to track the history of diamond ownership.

#### On Visa and Mastercard (both Outperform) - Moshe Orenbuch

We believe that developments in the payments industry over the past several years have solidified the roles of Visa and MasterCard. Specifically the evolution of Apple Pay as well as the other "pays" have all elected to use the existing "rails" and make the networks the "guardians" of the tokenization process. In contrast, the "joint ventures" that attempted to change the way consumers transacted (such as Isis/Softcard and MCX/CurrentC) have largely failed.

Consequently, in both card networks and consumer payments our view is consistent that bitcoin is unlikely to significantly penetrate mainstream payments, and is significantly more likely to be successful in niche markets. Given the enormous global opportunity to convert cash payments to electronic form (as over 80% of payments in developing markets are still cash-based) the prospect of bitcoin's potential growth is not a concern for our forecasts for the bankcard networks.

Distributed Ledger Technology could work in payments, and has the potential to disintermediate transaction flow, in theory. In practice, we would expect that there are many use cases for the technology that are more suited, particularly those where the number of transactions is not as large. VisaNet processes about 2000 transactions per second and has capacity for 25x that level, while a distributed ledger approach is limited to a single digit number of transactions per second, likely rendering blockchain applicable only in niche markets.

While as a whole we remain more cautious in the consumer space, we see greater opportunity within financial services.



**Financial Services Payments: Nobody Wants to Be Left Out - Paul Condra**

Across the US fin-tech landscape we see widespread willingness among bank infrastructure and payment providers to invest in blockchain start-ups and/or internal initiatives. While these investments are likely several years away from becoming significant revenue drivers, we believe providers want to ensure they have a seat at the table as financial institutions (i.e., their customers) increasingly look to the technology to provide operational efficiencies or a competitive edge.

We believe large financial institutions have never been under more pressure to reduce costs and differentiate their offerings. New regulations, the threat of data security and demand for transparency are colliding with the growing threat of disintermediation from fin-tech start-ups. Many of these start-ups are leveraging the fact that back-end transaction processing and data storage – what used to be a core-strength of financial providers – has largely been commoditized, enabling them to offer similar products at lower prices.

As large banks contemplate use-cases for blockchain, we believe bank-to-bank payment systems and various trade finance products present some of the lowest-hanging fruit for disruption. These systems, such as SWIFT, are decades old, have very limited flexibility and face growing security threats (note SWIFT's recent security breaches). They are also slow and costly – with cross-border wire-payments taking days to clear with fees as high as 10%.

Enter blockchain – a low-cost, instant, virtually un-hackable, fully automated, end-to-end transaction system built on a private permission-based network. Such a system would not only enable banks to eliminate costly overheads, but would provide a lower-cost money transfer product attractive to large multinational organizations with high frequent cross-border funding and trade finance demands.

We believe there will be other use cases for blockchain and expect fin-tech providers to continue to make investments in its development. We highlight some examples below.

**Select Blockchain Initiatives of Payment and Fin-Tech Firms**

- **Fiserv (FISV)** is an investor in Chain, which is working to build an open source blockchain protocol. Other investors/participants include Citi, Nasdaq, Fidelity, Pfizer, and State Street.
- **First Data (FDC)** is also an investor in Chain. First Data is testing the platform to offer gift cards for SMBs using blockchain on its online gift card platform, Gyft.
- **DH (DH)** has partnered with Ripple Labs and has also integrated an internally developed blockchain solution directly into its payment hub software that is currently in a trial phase.
- **Dwolla** is investing in blockchain applications to help banks record, manage and move assets.
- **Digital Asset Holdings** is a blockchain startup notable for its board members, which include Cristobal Conde, the former CEO of SunGard (now part of FIS) and Chris Church, a former senior executive at SWIFT.
- **Earthport**, a cross border payments specialist, has invested in distributed ledger technology to make cross-border correspondent banking transactions more efficient.
- **Paycommerce**, a SaaS payments and remittance platform, is building its own permissioned closed-loop blockchain, allowing it to control which member bank sees which transaction to maintain privacy (similar to DH).

## Worldpay (WPG.L)

Rating	<b>OUTPERFORM [V]</b>
Price (29 Jul 16, p)	293.40
Target price (p)	300.00
Market Cap (£ m)	5,868.0
Enterprise value (£ m)	7,363.9

\*Stock ratings are relative to the coverage universe in each analyst's or each team's respective sector.

\*Target price is for 12 months.

[V] = Stock Considered Volatile (see Disclosure Appendix)

### Research Analysts

**Charles Brennan CFA**

44 20 7883 4705

charles.brennan@credit-suisse.com

## Far from blocked

- Investor fears overplayed:** Recent incoming calls suggest that clients are wary of the potential disruptive threat from blockchain-related technologies. Our analysis suggests these fears are overplayed and we continue to believe Worldpay has a sustainable role as a payments facilitator in a structural growth industry. We reiterate our Outperform rating and 300p TP.
- Bitcoin unlikely to penetrate mainstream payments:** We believe cryptocurrencies like bitcoin are technical innovations that address the complex problem of preventing double spending electronic currency and providing trust in a trustless ecosystem. However, we also believe that there are sufficient barriers that prevent mainstream adoption; for instance if you lose your private key, then the associated bitcoin can never be recovered; a clear problem for anyone who has ever forgotten a password. Consequently, we believe that cryptocurrencies will only be used in niche scenarios, notably where participants value the benefits of anonymity. In our meetings with Worldpay, it is clear the company has been keeping a close watching eye on bitcoin since 2014 and has built programs to support it. However, according to the Head of Innovation at Worldpay, limited customer demand means there has been no pressure to commercialise the offering, supporting our view that bitcoin is likely to remain a niche payments method for now.
- Traditional payments infrastructure intact:** Elsewhere, a distributed ledger is technically capable of disintermediating central parties, but in reality we see limited risk for the card networks. In particular, the current consumer experience is good; near instantaneous authorization, the ability to use cards globally with the same guarantees that ensure full delivery of goods/services or the ability to claim refunds. We think it is difficult to see how a new technology (with unproven scalability) can compete with this consumer experience that has been developed over decades. Consequently, we see limited scope for disruption in the existing four-party system that includes companies like Worldpay.

### Share price performance



The price relative chart measures performance against the FTSE 100 IDX which closed at 6724.4 on 29/07/16. On 29/07/16 the spot exchange rate was £.84/Eu 1.- Eu.9/US\$1

Performance	1M	3M	12M
Absolute (%)	9.4	9.9	
Relative (%)	3.6	2.2	

### Financial and valuation metrics

Year	12/15A	12/16E	12/17E	12/18E
Revenue (£ m)	981.7	1,107.2	1,213.6	1,332.0
EBITDA (£ m)	406.1	453.7	503.9	560.6
Pre-tax profit adjusted (£ m)	188.10	295.32	333.31	382.08
CS EPS (adj.) (p)	8.18	10.78	12.33	14.14
Prev. EPS (p)	-	-	-	-
ROIC (%)	12.0	11.2	12.6	14.2
P/E (adj.) (x)	35.8	27.2	23.8	20.8
P/E rel. (%)	218.2	157.1	158.9	157.0
EV/EBITDA (x)	18.0	16.3	14.4	12.6
Dividend (12/16E, £)	1.63	Net debt/equity (12/16E,%)		196.3
Dividend yield (12/16E,%)	0.6	Net debt (12/16E, £ m)		1,547.8
BV/share (12/16E, £)	0.4	IC (12/16E, £ m)		2,336.5
Free float (%)	64.9	EV/IC (12/16E, (x))		3.2

Source: Company data, Thomson Reuters, Credit Suisse estimates

## Fiserv, Inc. (FISV)

Rating	<b>NEUTRAL</b>
Price (29-Jul-16, US\$)	110.43
Target price (US\$)	101.00
52-week price range	110.92 - 80.07

\*Stock ratings are relative to the coverage universe in each analyst's or each team's respective sector.

<sup>1</sup>Target price is for 12 months.

### Research Analysts

**Paul Condra**  
212 325 8903  
paul.condra@credit-suisse.com

**Mrinalini Bhutoria**  
212 325 2691  
mrinalini.bhutoria@credit-suisse.com

## Well positioned to compete

- Key Provider of “Blockchain-able” Services:** Given FISV currently trades at peak multiples, we believe the market has little regard for potential blockchain disruption and is more attuned to its entrenched position among its customer-base and strong recurring revenue characteristics. Nevertheless, as a leading provider of core bank processing and bank payment systems, we believe FISV sits at the center of potential blockchain evolution. Over time, as blockchain-based applications develop around these core financial services, we believe FISV could face new competition in the bank technology space.
- Large Banks Will Likely Adopt First:** As is usually the case with bank technology, we expect the largest banks will lead the effort to incorporate blockchain technology into their core offerings. Only after these use-cases are proven out would we expect to see the emergence of applications more relevant to the small and mid-size bank sector (FISV’s core customer base).
- Could be delicate balancing act:** While we fully expect FISV to be a fierce competitor in a blockchain world, it may find itself in a delicate position of having to balance the growth of legacy products against expanding demand for lower-cost next generation blockchain products. Fortunately, the long selling cycle inherent to the banking space could be a favorable offset to this dynamic.

### Share price performance

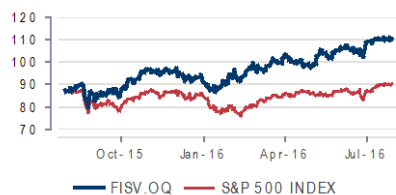

On 29-Jul-2016 the S&P 500 INDEX closed at 2171.96  
Daily Jul30, 2015 - Jul29, 2016, 07/30/15 = US\$87.58

Quarterly EPS	Q1	Q2	Q3	Q4
2015A	0.89	0.95	1.03	1.01
2016E	1.06	1.06	1.16	1.15
2017E	1.19	1.19	1.29	1.35

### Financial and valuation metrics

Year	12/15A	12/16E	12/17E	
EPS (Excl. ESO) (US\$)	3.87	4.44	5.01	
EPS (CS adj., )	3.87	4.44	5.01	
Prev. EPS (CS adj., US\$)	-	-	-	
P/E (CS adj.) (x)	28.5	24.9	22.0	
P/E rel. (CS adj., %)	154.1	135.0	135.5	
Revenue (US\$ m)	5,254.0	5,543.1	5,859.1	
EBITDA (US\$ m)	1,789.0	1,925.1	2,075.5	
Net Debt (US\$ m)	4,018	4,298	3,978	
OCFPS (US\$)	5.66	6.57	7.17	
P/OCF (x)	16.2	16.8	15.4	
Number of shares (m)	222.33		Price/Sales (x)	4.65
BV/share (Next Qtr., US\$)	42.4		P/BVPS (x)	2.7
Net debt (Next Qtr., US\$ m)	4,309.6		Dividend (current, US\$)	-
Dividend yield (%)	-			

Source: Company data, Thomson Reuters, Credit Suisse estimates

## DH Corporation (DH)

Rating	<b>OUTPERFORM</b>
Price (29-Jul-16, C\$)	32.25
Target price (C\$)	40.00
52-week price range	43.22 - 29.12
Market cap (C\$ m)	3,443.61

\*Stock ratings are relative to the coverage universe in each analyst's or each team's respective sector.

†Target price is for 12 months.

### Research Analysts

**Mrinalini Bhutoria**

212 325 2691

mrinalini.bhutoria@credit-suisse.com

**Paul Condra**

212 325 8903

paul.condra@credit-suisse.com

## Near-Term Blockchain Disruption Threat Low

- Blockchain Experimentation Begins:** DH is a provider of lending, core processing and transactional banking technology and hubs to small and mid-sized financial institutions. It has partnered with Ripple and developed a private blockchain internally in light of blockchain technology gaining popularity as a potential solution for inefficiencies in the banking sector.
- Well-Qualified, But Disruption a Ways Away:** Banks are increasingly relying on third party providers to help them remain competitive and profitable among heightened margin and regulatory pressures. Together, these parties are beginning to experiment with blockchain technology to address existing problems in areas such as international remittances, asset transfers, and property records. Although this doesn't pose a real disruptive threat to existing mission critical processes, we think it will help grow client confidence in the blockchain and provide a basis for future disruption. DH's position as technology provider to 8,000 banks and financial institutions puts it in a good position to help banks identify and implement blockchain use-cases.
- Blockchain still too nascent to be relied upon:** Until the blockchain ecosystem achieves greater certainty and stability, we believe banks are unlikely to rely on a technology that is less than 10 years old for mission-critical business activities.

### Share price performance

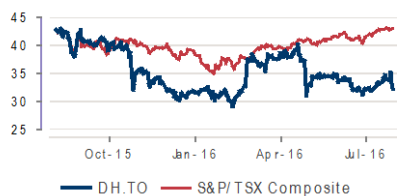

On 29-Jul-2016 the S&P/TSX Composite closed at 14582.74

Daily Jul31, 2015 - Jul29, 2016, 07/31/15 = C\$43.1

Quarterly EPS	Q1	Q2	Q3	Q4
2015A	0.55	0.59	0.61	0.78
2016E	0.44	0.56	0.60	0.67
2017E	0.44	0.58	0.68	0.75

### Financial and valuation metrics

Year	12/15A	12/16E	12/17E
EPS (Excl. ESO) (C\$)	2.78	2.28	2.45
EPS (CS adj., )	2.78	2.28	2.45
Prev. EPS (CS adj., C\$)	-	-	-
P/E (CS adj.) (x)	11.6	14.2	13.2
P/E rel. (CS adj., %)	61.0	73.0	82.6
Revenue (C\$ m)	1,528.2	1,716.9	1,799.1
EBITDA (C\$ m)	496.2	461.5	527.1
Net Debt (C\$ m)	1,993	1,821	1,662
OCFPS (C\$)	2.47	2.91	3.48
P/OCF (x)	12.8	11.1	9.3
Number of shares (m)	106.78		
BV/share (Next Qtr., C\$)	20.7	Price/Sales (x)	2.05
Net debt (Next Qtr., C\$ m)	1,895.2	P/BVPS (x)	1.5
Dividend yield (%)	-	Dividend (current, C\$)	-

Source: Company data, Thomson Reuters, Credit Suisse estimates

# Exchanges, Registrars and Custodians

## Use Case

### Research Analysts

**Karl Green**  
44 20 7888 2629  
karl.green@credit-suisse.com

**Andrew Adams**  
61 2 8205 4106  
andrew.adams@credit-suisse.com

**James Cordukes, CFA**  
61 2 8205 4858  
james.cordukes@credit-suisse.com

**Ashley N. Serrao, CFA**  
212 538 8424  
ashley.serrao@credit-suisse.com

**Martin Price**  
44 20 7883 7516  
martin.price@credit-suisse.com

**Takehito Yamanaka**  
81 3 4550 9150  
takehito.yamanaka@credit-suisse.com

*“There are basically three groups – there are the large banks, there are the exchanges, and there is the settlement system. And what's going to happen is one of those three are going to use this technology to disrupt the other two. I think that's the bottom line.”*

—Patrick Byrne, Phd. CEO, Overstock.com, November 20th, 2015

### Why settle for T+3?

There is a disconnect between the pre and post trade infrastructure. The 'arms race' in execution has taken us to a point where competitive advantage can be measured in millionths of a second. In contrast, post-trade infrastructure remains clunky: although T+2 is being introduced, currently the US settles for T+3.

This disconnect is nothing new. Even the Amsterdam Stock Exchange, considered the oldest in the world, saw faster trading speeds than settlement. Around 30 years after its founding in 1630, speculators were commonly selling 'shares which they did not possess at the time of sale, and surpluses were settled on rescontre' – settling day, a month later<sup>11</sup>.

In the 1700s the exchange had established links with the London Stock Exchange: Isaac de Pinto wrote in 1761 'whoever is in possession of actions, obligations secured by the state, annuities, or other stock in England, converts them into money at one percent, more or less, according to the market price at Amsterdam or London.' Cross-listed stocks included the Bank of England, East India Company, and the South Sea Company. Given the bearer nature of share certificates, settlement time had to be set to at least take account of the journey time – which during the 1700s was at least three days, 'yet the vagaries of wind, sea and sail often increased this distance to six days or more.'<sup>12</sup>

Ledgers and transfer books were meticulously kept; these records of transactions show that in 1750 there were over 60,000 total stockholders, and by the early 1800s, ten times that number<sup>13</sup>. Even at that stage, a clearing house sat between the transacting parties existed to obviate counterparty risk through a process of novation – the clearing house becoming the seller to every buyer, and the buyer to every seller.

**Figure 70: There is a clear disconnect between pre and post-trade infrastructure**

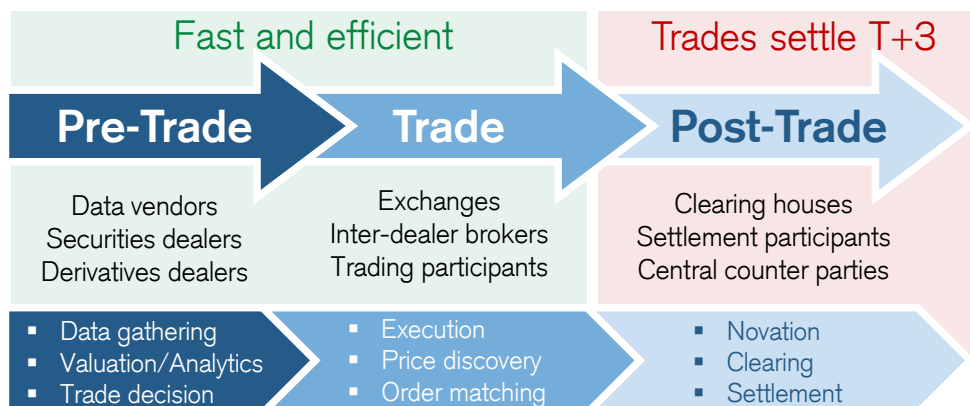

Source: Australian Financial System Inquiry, Credit Suisse Research

<sup>11</sup> Wilson, C. (1941). Anglo-Dutch commerce in the eighteenth century. Cambridge: Cambridge University Press.

<sup>12</sup> Dempster et al. (2000). A Common Features Analysis of Amsterdam and London Financial Markets During the 18th Century. Economic Inquiry, 38:1

<sup>13</sup> Carter, Alice Clare. Getting, Spending and Investing in Early Modern Times. The Netherlands:Van Gorcum, Assen., 1975.

### Nearing Real Time Capital Markets Settlement?

As the securities markets have deepened and broadened, settlement time has reduced. In the latter half of the 20<sup>th</sup> century the 14-day account was abandoned, and delivery versus payment (DVP) introduced on a rolling basis. Initially settling at T+5, then T+3, T+2 has been introduced in some locations. Reduced settlement time is attractive to participants in the capital markets as it reduces market risk, fees and most importantly credit risk.

### Figure 71: Failure rates, cost reduction and management of operational risk have been the most important motivations for faster settlement

Motivation for Implementing faster settlement:

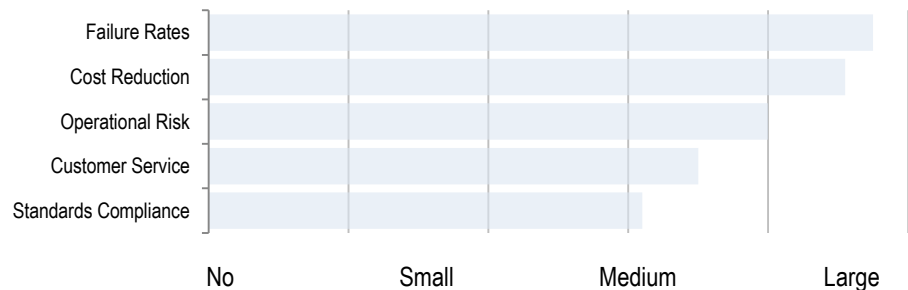

Source: Tower Group/SIA Survey, Technology Trends in the Securities Industry 1999: Transition to an Online World

A barrier to faster settlement has always been the materiality of share certificates, great friction is introduced by their physically transfer from custodial location to custodial location. However financial assets are dematerializing. Even in 2010, the FT estimated that for every two UK shares held as certificates, there were three held in dematerialized form; this number will have, and continues to accelerate. The EU Central Securities Depositories Regulation (CDSR – which already has legal force) will remove physical certificates by 2025, negating the need for physical ownership transfer. The question remains, why in an almost totally dematerialized world we still settle for such slow settlement relative to the exceptional speed of the pre-trade and price discovery infrastructure?

If we think about the answer in terms of ledger duplication it becomes easy to understand why the process is unwieldy. As in the below diagram, there are potentially as many as 10 distinct ledgers recording every transaction. This duplication requires multiple reconciliations among centralized ledgers, and complex, and often manual connectivity within this siloed system.

We see the different roles and responsibilities as follows:

- **Brokers:** Represent buyers and sellers in communication with trade and post-trade architecture.
- **Exchanges:** Fulfil the function of price discovery by matching buyers and sellers.
- **Clearing House:** Novates trades, becomes seller to every buyer, and the buyer to every seller; reduces risk of settlement failure.
- **Registrar:** Companies who keep a register of who owns what shares. The three main ones in the UK are Capita, Equiniti and Computershare.
- **CSD:** Holder of securities, often in dematerialised form, so that ownership is more easily transferred via book entry as opposed to physical transfer.
- **Custodian:** Specialized institution with fiduciary duty for a firm or individual's assets, not engaged in traditional commercial banking.

**Figure 72: Structure of the capital markets ecosystem**

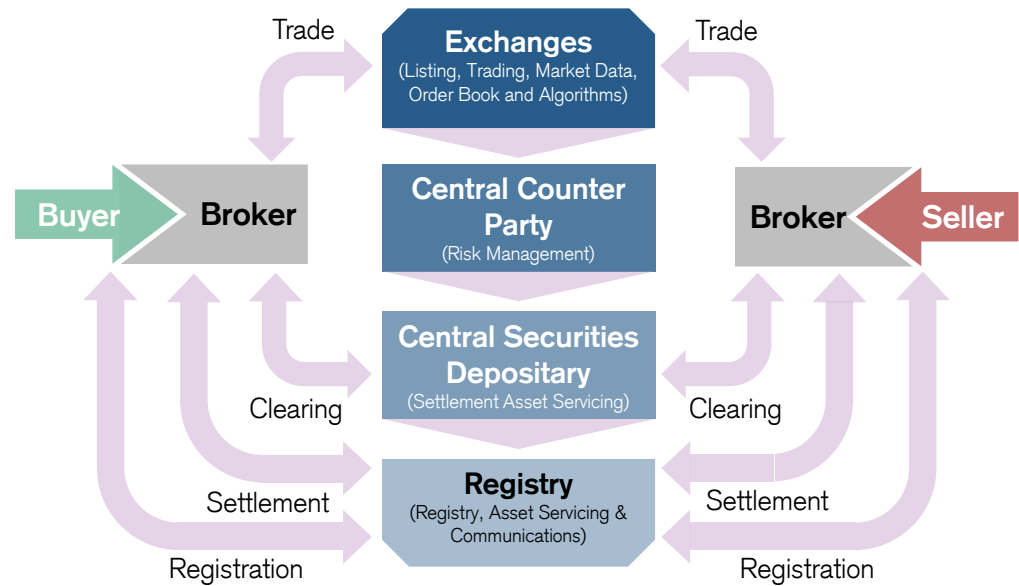

The post-trade environment is crowded

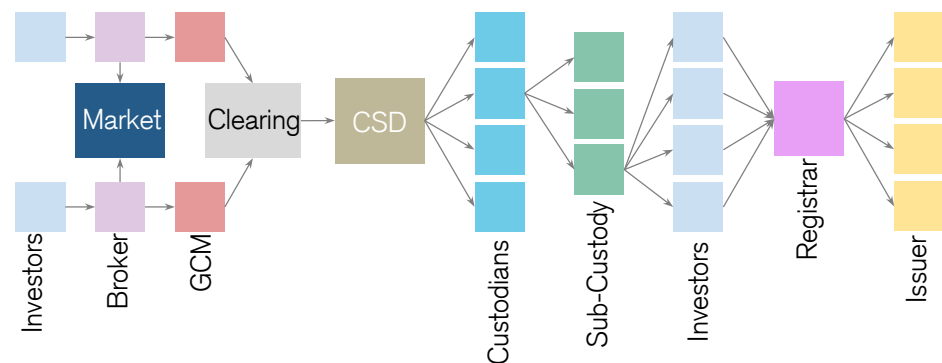

Source: Computershare, SETL, Credit Suisse Research

This architecture, mature and secure though it is, certainly appears as if it could be streamlined by introducing a shared ledger. While it is not clear exactly how this might be implemented, there is undoubtedly potential for aspects of the current architecture to be rationalized, vertically integrated or even rendered obsolete:

■ **The trade is the settlement**

Imagine one bitcoin is a dematerialised share certificate representing ownership; consider how it could be transacted between parties with trade and settlement as one, at T-near-instant speed. Now imagine the blockchain is a permissioned public ledger, making transactions less frictional and eminently more scalable than bitcoin. A shared ledger solution here could elegantly replace the myriad of ledgers maintained in the current architecture.

■ **T-0 settlement reduces costs of risk mitigation**

Clearing remains a fundamental part of the post-trade process because the speed of execution is many times faster than the cycle time of the asset transfer underlying the



transaction. This creates significant credit risks which have to be managed: the longer they have to be mitigated, the greater the risk borne. We therefore see some proportionality between the speed of settlement and the magnitude of compensation for bearing of risk assumed during the novation process.

■ **Smart contracts service assets**

With dematerialisation, custodians' main value proposition has shifted from safeguarding of the physical securities towards DVP and particularly asset services. Should dematerialised shares be settled and cleared on a blockchain – it is theoretically possible to embed smart contracts to govern dividend and interest remittance, rights issues, proxy votes and other services.

**Figure 73: A permissioned public ledger with control layers and provision for smart contracts is likely to be the most suitable ledger type for the capital markets**

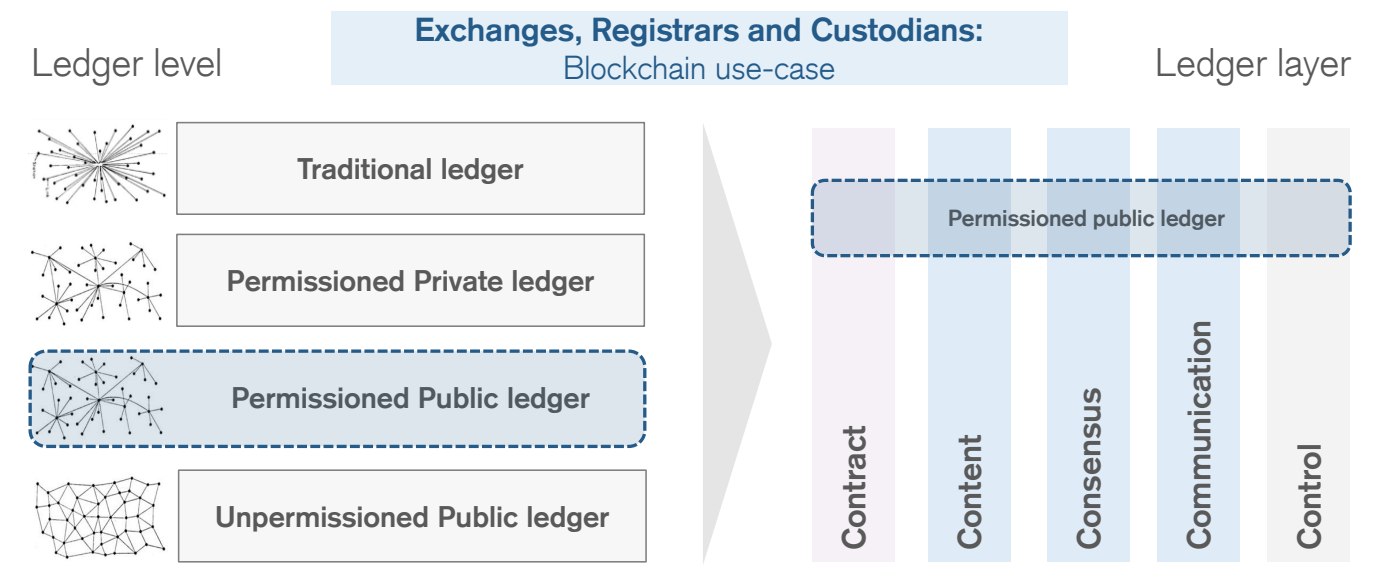

Source: Credit Suisse research based on data from Consult Hyperion and On Distributed Communications Networks by Paul Baran, 1962

**Who is the chain curator?**

A key issue we believe bitcoin reveals about some blockchain-based solutions is irrecoverability and irreversibility of transactions. This is a result of public key encryption, which is employed to enable anonymity on the chain. While we think identity must be encrypted on any capital markets blockchain solution – buyers and sellers demand anonymity – we also think it is imperative there is provision for recovery of assets, and that erroneous 'fat-fingers' are reversible.

Thus we envisage a public ledger, similar to that of bitcoin, which encrypts the transacting identity, but leaves the flow visible – perhaps on a fee basis. Permissioned entities preside over the chain to 1) manage reversals of trades, and 2) to act as the link between on-chain and off-chain identity.

In our view, the node permissioned to administer transaction reversals should be intrinsically linked to execution – the best positioned would appear to be the broker, the exchange, or a combination of the two. The node engaged with securely storing and managing identity in order to reconcile on and off-chain ownership should have an intimate relationship with the client – we think the natural party to fulfil this role is the registrar.

**Figure 74: Opportunity for vertical integration**

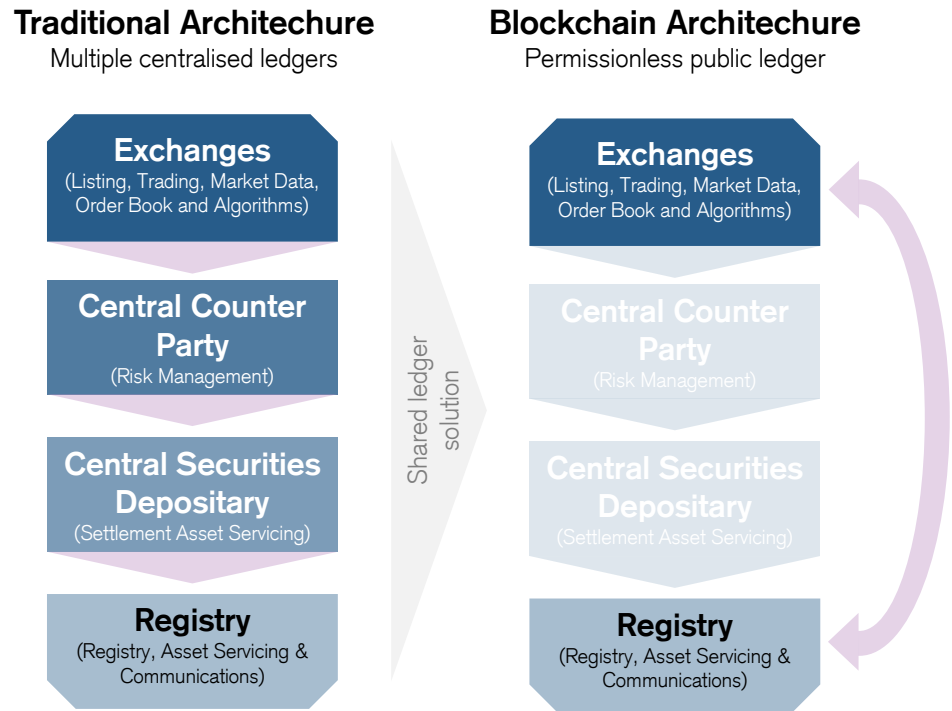

Source: Computershare, Credit Suisse research

Which functions appear undisruptable:

- **Price discovery:** None of our analysis has suggested there is a more efficient method of price discovery enabled by blockchain. Therefore, it appears this core value proposition should remain intact, the front office trading and execution systems of brokers and exchanges remaining somewhat insulated.
- **Netting:** ASX show the risk reduction and efficiency benefits of netting during the clearing below. We have discussed how faster settlement would naturally reduce risk, but the netting benefits for payments made would be lost. T-instant settlement would require 884k daily monetary transactions, while T+2 would enable a 98.5% reduction once netted to only 13k.

Were the payments infrastructure frictionless, this would not be an issue, but as transactions mean transaction costs, and our team are challenged to see a world functioning on a blockchain-based payments system, we think economics of a T-instant system also appear to face substantial obstacles.

- **Clearing function:** As the economics of T-instant settlement appear challenged without a frictionless payment system, this implies there will be risk which requires mitigation. Therefore we think that although the aggregate risk needing to be managed will reduce, there will still be need for a novating party.

**Figure 75: With later settlements comes the efficiency benefits of netting**

**Clearing services – benefits of netting**

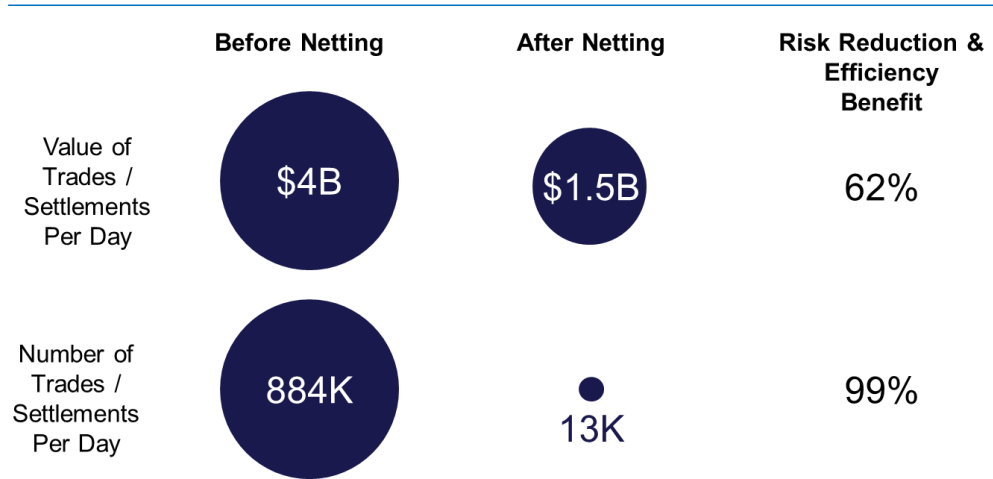

Source: ASX, Credit Suisse research

- **Registration:** The registrar currently is empowered as the 'single source of truth'. We think this function remains necessary to reconcile on and off-chain identity until such a time as the blockchain identity problem is solved.

We do note, however, that other parties may impinge upon this role. For example, ASX's CHESS held \$1.64 trillion AUD of securities in mid-2015 across 1,948,631 accounts and 12,316,496 equity holdings. CHESS also provided registration of title on its own sub-register. While we still think the natural guardian of ownership remains the registrar, and note this situation is unique to Australia, this underlines to us the importance of forward-looking investment across the value chain to ensure the moating of their competitive position.

**A totally 'on-chain' world?**

It is academically conceivable that in a blockchain-based capital markets infrastructure the trade becomes the settlement, resulting in a truly T-instant architecture – in addition the entirety of the transaction is contained on-chain in trustless fashion without the need for intermediaries.

However, we think you need to make five key assumptions to be confident this is:

- **A frictionless payment system** – for T-instant settlement to be economic
- **A solution to the identity problem** – to replace the registrars
- **Smart contracts that work** – so asset services are performed 'on-chain'
- **Total adoption** – in order for a comprehensive 'single source of truth'
- **Regulator backing** – regulated marketplaces rarely change without blessing

**The potential benefits of blockchain for exchange stakeholders**

ASX has been bullish about the benefits of blockchain and Distributed Ledger Technology. By nature blockchain will reduce the complexity and cost of the financial system and will significantly reduce (if not eliminate) the role of intermediaries and some of the functions within our financial system. ASX has been quick to highlight the benefits of blockchain technology to a range of stakeholders including:

- **Investors:** consolidated view of holdings; real time transactions and dividend receipts; simplified tax reporting obligations;
- **Issuers:** more efficient transparency of shareholder base;
- **Intermediaries:** risk reduction and lower margin postings due to real time settlement, simplified market will lower back off costs; reduce burden/cost of anti-money laundering and other Know Your Client obligations;
- **Regulators:** improved market oversight from higher transparency and clearer order trail; and
- **Exchanges:** lower costs; risk reduction due to faster settlement and likely reduction in capital holdings; new revenue opportunities for tailored settlement services and data services.

# Analyst View

## Global Exchanges Team

### Research Analysts

**Andrew Adams**

61 2 8205 4106

andrew.adams@credit-suisse.com

**Takehito Yamanaka**

81 3 4550 9150

takehito.yamanaka@credit-suisse.com

**Ashley N. Serrao, CFA**

212 538 8424

ashley.serrao@credit-suisse.com

**Martin Price**

44 20 7883 7516

martin.price@credit-suisse.com

**Christian Bolu**

212 538 9805

christian.bolu@credit-suisse.com

**James Cordukes, CFA**

61 2 8205 4858

james.cordukes@credit-suisse.com

**Richard Fellingner**

212 325 7909

richard.fellingner@credit-suisse.com

### Market opportunity

Blockchain offers a new approach to data management and sharing which we think has potential to change the way securities markets function, making them cheaper and more resilient. The technology could be particularly well suited to Post Trade applications in our view. Distributed ledgers could help streamline the process of holding and transferring assets. Existing settlement and registration/depository infrastructure can be complex and inefficient. As such, we think that depositories and custodians will be the first parts of the market infrastructure to apply blockchain. We expect exchanges to benefit as cheaper operations lead to higher volumes and lower costs.

One of the key financial benefits of blockchain is that it could lower the end to end cost of equity markets. In Australia, for example, ASX has estimated the total costs at around A\$4bn to A\$5bn, with ASX accounting for only a small proportion of this (perhaps 10-15% on our back-of-the-envelope estimate). As a consequence of blockchain, the revenue pie will shrink as certain services become redundant and costs reduce, although the impact will be different for the various players along the value chain. SETL for example estimate that US\$80bn of costs could be driven out of the global post-trade environment.

The extent of reduction is yet to be determined but one could easily imagine a scenario of >20% in overall costs of the equity market. The silver lining of new technologies is that there will be new revenue opportunities from additional services which can be used to re-grow the pie.

As such we expect Distributed Ledger Technology/blockchain to lead to a small reduction in the total cost of equity markets (i.e. the revenue base), while at the same time redistributing that revenue to different players through redundancy of current services, cost savings (which may be competed away) and the introduction of new services. It will be up to players across the value chain to jostle for its share of the new pie.

### Who wins and who loses?

Overall, we think the efficiencies delivered by blockchain should benefit the market by enhancing efficiency and lowering costs. Lower processing costs can result in increased volumes which would likely benefit exchanges with significant cash trading and derivatives businesses such as BME, Deutsche Boerse and Euronext in Europe or clearing flow such as LSE via its majority ownership of LCH Clearnet.

Shorter settlement cycles could reduce net interest income generated by clearing houses and custodians, which is typically derived from cash margin balances at clearing houses or funds deposited at a custodian in advance of a scheduled settlement obligation, although the impact may be at least partly offset by lower costs. We do not expect CSDs to be disintermediated but think they are likely to perform similar functions as they do now but more efficiently. While theoretically the core functions of a CSD could be performed by a distributed ledger, regulators are likely to have a preference for regulating a central authority (such as a CSD) with complete visibility over key components of the post trade value chain.

The European exchanges generate comparatively little income from settlement, partly as a result of certain core settlement functions being outsourced to the ECB's Target2Securities platform, which is being operated on a not-for-profit basis. Deutsche Boerse has greatest exposure to custody services at c.15% of group revenue although we do not expect this to disappear.

**Distributed ledgers poorly suited to trading**

We think there is potential for using distributed ledger technology in certain post trade processes, but the technology is likely to be too slow for adoption in trading applications. While a bitcoin transaction takes roughly 10 minutes to be confirmed, exchanges routinely match orders in microseconds. Decentralized systems such as blockchain require significant computing and storage resources because all nodes perform validation checks and store the ledger data, which in turn slows the system down.

**Settlement & custody – more suitable use-cases**

We believe the application is potentially best suited to payment functions such as settlement and asset ownership/servicing functions such as registration and custody. For instance, blockchain could provide a secure, consistent 'source of truth' of the ownership of assets to other market infrastructure providers such as custodians, central securities depositories and beneficial owners.

The success of bitcoin as a mechanism for transferring value with finality of execution on a common ledger demonstrates that for a simple case, the delivery vs. payment settlement can be programmable and managed in near real time. As the technology matures and scales, distributed ledger technology is potentially well suited to replacing existing settlement infrastructure.

The application of technology reducing settlement cycles could lower risk, by reducing exposure to trade settlement failures (e.g. dealers have less time to be exposed to counterparty risk) and lowering clearing fund requirements accordingly. In cash equities, trades in Europe typically settle on a T+2 basis while the US operates on a T+3 cycle (i.e. trades are settled two or three days after a trade was executed).

**Registration & custody**

The core function of a depository is to maintain a register of who owns what and to keep this updated as part of the settlement process. While existing applications generally work well, registration processes can be complex, inefficient and prone to error. We think blockchain could help solve many of these issues by making the register of owners available on a near real-time basis to permissioned entities such as clearing houses, custodians and agent banks.

Typically asset owners interact with central securities depositories via agent banks and custodians. Again, we see scope for a distributed ledger to increase efficiency by allowing custodians to interact with asset owners and CSDs via a permissioned distributed ledger. While blockchain could change the way that custodians work, we do not believe it removes their core functions (e.g. we see a continued need for entities with responsibility for asset safekeeping and management of corporate actions on behalf of asset owners).

**Clearing houses still have a role to play**

There is an ongoing debate about whether blockchain will disintermediate clearing houses, but we do not believe this to be the case. We believe CCPs will continue to perform a key role in mitigating risks for buyers and sellers by guaranteeing trade completion even if one side defaults, managing pre-settlement netting which greatly reduces the number of settlements that are needed, which also lowers funding costs. CCPs also support brokers and other agents by connecting buyers and sellers that do not have liquidity to settle trades themselves.

**How likely is this to happen?**

While there are strong arguments that shortening settlement cycles and moving to near real time settlement would reduce systemic risk and lower funding needs, implementation may prove challenging. Overall, we believe existing market infrastructure providers are best positioned to implement the new technology.

**■ Inertia and expense of investing in new technologies**

First, moving settlement to a distributed ledger would require significant industry investment to modernize legacy systems and resources to maintain both environments for a period of time. Attempts to do this historically have proven extremely costly and time consuming. For example, the ECB's plan to develop the 'Target2Securities' single European settlement system has taken nearly 10 years to implement and cost more than €1bn. The success of a settlement system based on blockchain is also likely to require all of that asset to be on the ledger or full integration with all of the off-chain assets, including all legacy custodians of those assets, as well as assets that may have been implemented on other chains/ledgers. Another complication is that global regulatory requirements for data privacy are different based on geography which would raise additional challenges for decentralised systems such as blockchain, which distributes every transaction to every node.

**■ The trade becoming the settlement is achievable without blockchain**

Second, near "real-time" settlement is often achievable with existing settlement infrastructure. In the US the DTCC's equity and fixed income settlement process occurs in real time throughout the day, so the distributed ledger may not in itself improve on that capability. While many settlement systems often have the ability to operate in real time, legacy market infrastructure is not set up this way. The DTCC receives new trades in real-time and processes settlement of those trades three days later; the delay is often imposed by market convention, laws and regulation rather than technical capability.

**■ Netting benefits are reduced by lowering settlement speeds**

Finally, real-time settlement may negate the benefits of pre-settlement netting. For example, two dealers could execute thousands of trades which each other all day. While each of these could be settled in real time it would result in significant and unnecessary transfers of cash. Typically a clearing house will facilitate pre-settlement multilateral netting of trades which allows market participants to settle only their net exposure at the end of each day. In the US, for example, over 97% of daily equity trades are settled through netting and only 3% go through the full settlement mechanism, according to the DTCC.

**Australia could be the testing ground for blockchain technology**

We believe Australia provides the ideal testing ground for blockchain technology most relevant to financial exchanges. Australia's market infrastructure is considered world class and is large enough to be a meaningful test environment, yet is also simpler than both the US and European operating environments.

In Australia, the market structure has only a single exchange and clearinghouse (albeit two trading platforms – ASX and Chi-X), has transparent share ownership rules (unlike the US street and non-street system) and has a concentrated ownership structure with ASX owning the trading, clearing and settlement functions across both equity and futures markets. In addition there is a willingness of industry participants to invest (eg ASX, Computershare, the government) in blockchain and other Distributed Ledger Technology.

Over the last year we have seen the announcement of two initiatives using blockchain technology. ASX has appointed Digital Asset as ASX's preferred partner to develop a Distributed Ledger Technology solution to address the post-trade needs of the Australian cash equities market. At the same time Computershare has partnered with SETL to undertake a joint initiative (which will initially focus on Australia) to "examine the practicalities of establishing an immutable register of securities ownership using blockchain technology".

There is a conducive regulatory regime with strong support from the Government. In March 2016 Federal Treasurer Scott Morrison commented:

*"The government also recognizes the potential benefits of the ASX's investment in distributed ledger technology (blockchain) for the Australian market. The government and the CFR agencies will continue to work with the ASX as it progresses this initiative, while identifying any regulatory barriers and ensuring that technological advancements do not preclude competition."*

The Council of Financial Regulators has also established a working group to coordinate research into blockchain innovations, including potential implications for the financial system.



## ASX (ASX.AX / ASX AU)

Rating	<b>NEUTRAL</b>
Price (29-Jul,A\$)	49.70
Target Price (A\$)	45.00
Target price ESG risk (%)	NA
Market cap (A\$m)	9,621.7
Yr avg. mthly trading (A\$m)	460.4
Projected return:	
Capital gain (%)	-9.5
Dividend yield (net %)	4.1
Total return (%)	-5.4

\*Stock ratings are relative to the relevant country benchmark.  
†Target price is for 12 months.

### Research Analysts

**Andrew Adams**  
61 2 8205 4106  
andrew.adams@credit-suisse.com

**James Cordukes, CFA**  
61 2 8205 4858  
james.cordukes@credit-suisse.com

## Priced for the blockchain bull case

- Blockchain could be used for post-trade services.** ASX's CHES settlement system is nearing the end of its useful life, with potential for ASX to upgrade to a blockchain-based post-trade service. We think this leads to 1) Potential elimination of clearing services (~7% of ASX's revenues); 2) The partial or full recapture of lost revenues through higher settlement / post trade service pricing, 3) Likely lower costs with the blockchain investment costs offset by efficiency gains and elimination of clearing costs, 4) Reduction or elimination of clearinghouse capital and its associated interest earnings, and 5) The introduction of new services (eg data analytics).
- Pricing is the key driver of profitability.** Ultimately, it comes down to what price ASX can charge for its new post trade services. While historically it has been considered that ASX has a monopoly in clearing and settlement, we note there is now scope for new competitors to emerge and the regulator appears to be playing an increasingly strict hand in pricing/profitability. We see downside risk to ASX's existing equity post trade services EBITDA margin (currently 70-80%), particularly when the release of clearinghouse capital won't allow ASX to argue the need to earn an appropriate return on capital (currently ~15%). ASX will need to find the right balance between providing an attractively and profitably priced service (noting that the back office costs savings will be quite high for participants, giving ASX some pricing power), but not so high as to over-earn and encourage new entrants.
- ASX priced for the bull case.** In our 'bull' case scenario for ASX we expect blockchain to provide small upside (+3% NPAT) while our 'bear' case suggests modest downside risk (-8% NPAT). ASX is trading on c.22x 12mth forward earnings, high for a company with a relatively low growth outlook and implying a lot of certainty around long term future earnings (i.e. 10 years+). Given our 'bull' case results in only small upside, with the end outcome a lot less certain (including potential downside risk) we conclude that ASX's 'bull' case is already priced in with downside risk for a more pessimistic scenario.

### Total return forecast in perspective



Source: Company data, Thomson Reuters, IBES, Credit Suisse estimates

Performance	1M	3M	12M
Absolute (%)	10.44	13.65	13.44
Relative (%)	2.28	7.75	15.33

### Financial and valuation metrics

Year	6/15A	6/16E	6/17E	6/18E
Revenue (A\$ mn)	701	748	777	810
EBITDA (A\$ mn)	541	578	600	626
EBIT (A\$ mn)	502	536	555	577
Net Income (Adj.) (A\$ mn)	403	425	435	450
EPS (Adj.) (A\$)	2.08	2.20	2.25	2.33
Change from previous EPS (%)	n.a.	0.0	0.0	0.0
EPS growth (%)	5.0	5.3	2.4	3.5
P/E (x)	23.8	22.6	22.1	21.4
Dividend (A\$)	1.87	1.98	2.02	2.09
Dividend yield (%)	3.8	4.0	4.1	4.2
Price/Book (x)	2.6	2.5	2.5	2.5
Net debt/equity (%)	Net Cash	Net Cash	Net Cash	Net Cash

Source: Company data, Thomson Reuters, Credit Suisse estimates

## Australian Stock Exchange (ASX.AX)

*"Distributed Ledger Technology could provide a once in a generation opportunity to reduce cost, time and complexity in the post-trade environment of Australia's equity market."*

*- Elmer Funke Kupper, Managing Director and CEO of ASX, 21<sup>st</sup> Jan 2016*

### **ASX will be forced to adopt new technology**

Technology is going to change the market infrastructure in Australia and around the world. It will be important for ASX to invest in and support the right technologies. Distributed Ledger Technology (of which blockchain is one form) is likely to play a key role in the financial system in years to come and ASX has no choice but to embrace the new technology and ensure it is part of the 'rebuilt' market infrastructure.

We believe that the time is ripe for a technological upgrade to the cash equities clearing and settlement system. After ~20 years, ASX's CHES settlement system is nearing the end of its useful life. Over the last decade we have seen significant upgrades to trading platforms, with trade times dropping to microseconds and nanoseconds. However, post trade services (ie clearing and settlement) remain slow with the latest round of platform upgrades reducing settlement times to two days (T+2) from three days (T+3). Blockchain and related technologies will modernize the post trade world allowing for real-time settlement.

One of the key financial benefits of blockchain is that it will lower the end to end cost of our equity market. In Australia, ASX has estimated this total cost at around A\$4bn to A\$5bn, with ASX accounting for only a small proportion of this (perhaps 10-15% on our back-of-the-envelope estimate). As a consequence of blockchain, the revenue pie will shrink as certain services become redundant and costs reduce, although the impact will be different for the various players along the value chain. The extent of reduction is yet to be determined but one could easily imagine a scenario of >20% in overall costs of the equity market. The silver lining of new technologies is that there will be new revenue opportunities from additional services which can be used to re-grow the pie.

As such we expect Distributed Ledger Technology/blockchain to lead to a small reduction in the total cost of equity markets (ie the revenue base), while at the same time redistributing that revenue to different players through redundancy of current services, cost savings (which may be competed away) and the introduction of new services. It will be up to ASX to jostle for its share of the new pie.

ASX is generally considered to be operating under a monopoly market structure, which from an economic point of view can sometimes encourage underinvestment and a lack of innovation. However, we believe that this is a key advantage for ASX which is very proactive at investigating new technologies and have the available capital to invest and build new systems that will hopefully entrench its dominance going forward. As discussed below, ASX is currently undertaking a study into potential benefits of Distributed Ledger Technology.

### **The 'bull' and 'bear' cases for ASX**

We expect ASX to face both threats and opportunities from blockchain. As ASX has acknowledged, Distributed Ledger Technology could eliminate the role of clearing as settlement becomes real time which would essentially eliminate the ~A\$55mn or 7% of ASX's FY16E revenue base that relates to cash equities clearing. While there could also be further downside for other clearing services (eg futures), cash equities seems to be the current focus.

At the same time ASX would offer access to a new real time settlement service, of which the value of revenues will ultimately depend on the end pricing outcome. blockchain will

also enable ASX to develop new products and services which can add additional revenue streams.

We believe the 'bull' case for ASX will be a small positive (+3% upside to NPAT in our scenario below) with a small capital return while the 'bear' case could see downside risk to earnings (-8% in our simple scenario which is contained primarily to the impact on the cash equities business) with any capital released reinvested into the business.

### The 'bull' case

Within our 'bull' case, ASX would lose its clearing revenue stream, which could be replaced by settlement fees under the new settlement service which utilizes Distributed Ledger Technology. Pricing of the new service will be key to ensuring clearing revenues are replaced and will depend on ASX's ability to introduce appropriate pricing. Ultimately this will require ASX to effectively communicate to participants the benefits of the new settlement system. Given that participants will likely benefit from significant back office cost savings, they are likely to be willing to pay relatively lucrative rates to ASX which will still result in net benefits to both participants and the ASX (ie participants can lower costs but pay ASX a larger fee for the settlement service).

There could also be a number of new products and services that ASX could introduce to create new revenue streams. Examples include tailored settlement services, new liquidity services and a range of data analytics services.

Real time settlement would also release the \$250mn of capital in ASX Clear, the cash equities clearinghouse, which could be returnable to shareholders. We note that this is a somewhat optimistic assumption with likely a large part of the capital reinvested to fund new products and the Distributed Ledger Technology itself (noting that ASX has a dividend payout ratio of 90% currently). Nevertheless the interest on this capital would be lost (-1% NPAT impact).

In our 'bull' case scenario we have assumed that ASX will lose its clearing fees but be able to replace this revenue by doubling its settlement fees resulting in unchanged post trade revenues. However, we have also assumed that the cost base of the clearing business will be eliminated and that there will only be a 50% increase in the cost base of the settlement business which results in a 25% decline in the cost base of post trade services. This results in a 1% increase in NPAT in the post trade business which will be offset by the decline in interest income from the \$250mn in the clearinghouse (-1% NPAT impact). This means the majority of the 3% of upside in our 'bull' case comes from new services.

### Figure 76: Our 'bull' case has 3% earnings upside potential

	NPAT (A\$m)	% NPAT
FY20E NPAT	487.0	
0% Increase in Equity-Post Trade revenues (tax affected)	(0.3)	(0.1%)
...Elimination of Equity Clearing Fees (tax affected)	(41.7)	(8.6%)
...100% Increase in Equity Settlement Fees (tax affected)	41.4	8.5%
25% Decrease in Equity-Post Trade costs (tax affected)	5.5	1.1%
...Elimination of Equity Clearing costs (tax affected)	10.9	2.2%
...50% Increase in Equity Settlement costs (tax affected)	(5.4)	(1.1%)
Loss of interest income from \$250mn reduction in clearinghouse capital (tax affected)	(3.2)	(0.7%)
3.0% NPAT benefit from new services	14.6	3.0%
Pro-forma FY20E NPAT	503.5	3.4%

Source: Credit Suisse estimates

**The 'bear' case**

Within our 'bear' case, ASX would lose not only its clearing revenue but it may also lose some of its settlement revenues due to a new entrant or be unable to secure appropriate pricing on the new settlement system to recoup lost revenues.

ASX's ability to secure appropriate pricing could be a key risk (more so than other global exchanges). ASX's margins are very high in the cash equities clearing and settlement business with EBITDA margins of 70-80% and net profit margins of 50-60%. They are only justifiable because the return on capital is 12-18%. These rather attractive metrics are underpinned by ASX's rather high headline fees for post trade services, which are well above other exchanges (refer charts below).

**Figure 77: ASX clearing fees relatively expensive by global standards**

Cost of cash equities clearing for large firms (per side)

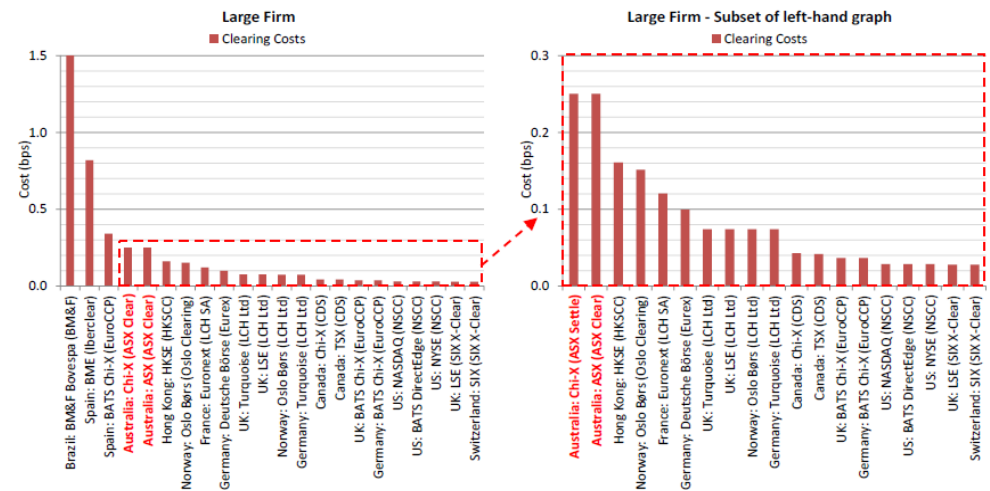

Source: Market Structure Partners "International Transaction Cost Benchmarking Review" (October 2014)

ASX charges a higher fee as it contributes more capital to the clearinghouse than its global peers who make greater use of participant funded default funds (refer table below). ASX sets its fees to ensure it gets a fair return on its capital (currently ~12% in the clearing business and ~18% in the settlement business). If Distributed Ledger Technology were to materially reduce the size of the default fund then ASX's return on capital would rise sharply under the current margins (noting we don't know how much capital ASX will be required to invest into the underlying technology itself). If its margins remain too high and returns too great, then it would likely encourage competition / new entrants and skepticism from the regulator and participants.

**Figure 78: ASX's contribution to the default fund higher than most exchanges**

in millions, unless otherwise stated

	Contribution to Capital by Exchange (A\$m)	Value of share trading (A\$bn)	Capital % Value traded (bp)
KRX (Korea)	0	1561	0.00bp
CDS (Canada)	0	1345	0.00bp
NSCC (USA)	48	13631	0.04bp
LCH.Clearnet (UK)	32	1237	0.26bp
CCASS (Hong Kong)	30	1121	0.27bp
Eurex (Germany)	66	1311	0.50bp
JSCC (Japan)	260	3110	0.84bp
CDP	24	258	0.93bp
ASX Clear	250	903	2.77bp

Source: Oxera "Global cost benchmarking of cash equity clearing and settlement services" report (June 2014)

Uncertainty also arises because we don't know who would own the Distributed Ledger Technology – perhaps ASX, perhaps ASX's partner Digital Asset of whom ASX has an 8.5% stake, or perhaps it could be another third party. The cash equities settlement system is only one component of our financial system. It is likely that our payments system will be overhauled and replaced with a new system using Distributed Ledger Technology, with the provider likely in a position to provide a competing service. Alternatively Digital Asset may provide the Distributed Ledger Technology service and charge ASX rent to access it or limit ASX's position to a singular node or miner within the system.

While some of the additional services are within ASX's core capability (eg tailored settlement services), we note that ASX may face competition in some of the potential data analytics services from providers who also have this capability or even Computershare.

Our bear case would also see most of the capital released into the default fund reinvested into the business, and note that if the technology is quite capital intensive it could require ASX to reduce its current 90% payout ratio to fund the investment.

Our 'bear' case, which implies 8% downside, assumes that ASX loses all its clearing revenues but also associated costs, is unable to reprice its settlement service result, sees its settlement cost base double, loses the margin income for lower clearinghouse capital and only benefits a little (+1%) from new services. We note that this would lower the EBITDA margin on post trade services from 70-80% to ~25% which is still a reasonable rate of return in itself.

**Figure 79: Our 'bear' case indicates 8% earnings downside potential**

	NPAT (A\$m)	% NPAT
FY20E NPAT	487.0	
50% Decrease in Equity-Post Trade revenues (tax affected)	(41.7)	(8.6%)
...Elimination of Equity Clearing Fees (tax affected)	(41.7)	(8.6%)
...0% Increase in Equity Settlement Fees (tax affected)	0.0	0.0%
0% Decrease in Equity-Post Trade costs (tax affected)	0.1	0.0%
...Elimination of Equity Clearing costs (tax affected)	10.9	2.2%
...100% Increase in Equity Settlement costs (tax affected)	(10.8)	(2.2%)
Loss of interest income from \$250mn reduction in clearinghouse capital (tax affected)	(3.2)	(0.7%)
1.0% NPAT benefit from new services	4.9	1.0%
Pro-forma FY20E NPAT	447.0	(8.2%)

Source: Credit Suisse estimates

**But ASX is priced only for the 'bull' case**

ASX is trading on c.22x 12 month forward earnings which is relatively high for a company with a relatively low growth outlook and implies a lot of certainty around long term future earnings (ie 10 years +). As we explained earlier, our 'bull' case may only result in small upside for ASX with the end outcome a lot less certain and which could involve downside to ASX's future earnings.

As such we conclude that ASX's 'bull' case is already priced in with downside risk for a more conservative or 'bear' case.

**On the front foot: ASX's blockchain investments**

In January 2016 ASX announced it was partnering with Digital Asset to develop solutions utilizing Distributed Ledger Technology. As part of the partnership, ASX also acquired a 5% stake in Digital Asset for A\$15m alongside 12 other global financial services companies.

Following an initial six-month scoping study, in June 2016 ASX contracted Digital Asset to develop a post-trade solution for the Australian cash equities market. ASX also exercised its option to increase its holding in Digital Asset to 8.5% (an additional 3.5%) at a cost of US\$7m and which gave it a right to appoint a Board member.

ASX will continue to investigate the opportunities for Distributed Ledger Technology and will make a final decision on a post-trade system in 2017.

As a result ASX has delayed the upgrade of its existing settlement system (CHES) and has gained the support of the regulator and government which delayed its decision to open up the cash equities clearing market to multiple competitors until ASX has investigated how Distributed Ledger Technology could change the market infrastructure.

## London Stock Exchange (LSE.L)

Rating	<b>OUTPERFORM</b>
Price (29 Jul 16, p)	2775.00
Target price (p)	2900.00
Market Cap (£ m)	9,720.8
Enterprise value (£ m)	10,027.2

\*Stock ratings are relative to the coverage universe in each analyst's or each team's respective sector.  
†Target price is for 12 months.

### Research Analysts

<b>Martin Price</b>
44 20 7883 7516
<a href="mailto:martin.price@credit-suisse.com">martin.price@credit-suisse.com</a>
<b>Tom Mills</b>
44 20 7888 8204
<a href="mailto:tom.mills@credit-suisse.com">tom.mills@credit-suisse.com</a>

## Blockchain – more opportunity than threat

- Low risk of disintermediation:** Blockchain has scope to change the way that markets work, potentially making them cheaper and more resilient. The technology is likely to be best suited to Post Trade applications such as settlement and custody in our view. LSE's exposure to these areas is currently low, but rises to c.10% of pro-forma revenue in the event of the DB1 merger closing. In our view, existing market infrastructure providers are best placed to apply the technology and we see little risk of disintermediation.
- Execution and clearing here to stay:** Decentralized systems like blockchain require significant computing/storage resources which slow the system down. A bitcoin transaction takes c.10 minutes to be confirmed which is too slow for trading applications which typically match trades in microseconds. Similarly, we believe clearing houses will continue to perform a key role in mitigating risks by guaranteeing trade completion and netting trades before they enter a distributed ledger. While clearing and NII make up 28% of LSE's standalone revenue, the company is well positioned to implement new technologies in our view and we think the risks of disintermediation are low.
- Potential upside in settlement/custody:** While existing settlement and custody applications work well, we believe blockchain could cut costs and increase efficiency in post trade functions such as these. LSE is experimenting with the technology in its newly established European CSD (globeSettle) which is currently undergoing core development. Similarly, we see opportunities for application in LSE's custody & asset servicing units.
- Reiterate Outperform (TP 2,900p):** LSE is trading on a modest premium to the sector for more than double the EPS growth over the next three years on our forecasts (18% vs. 7%). We expect superior growth to be driven by cost synergies from recent deals (e.g. LCH/Russell) and greater exposure to rapidly growing areas such as index services and clearing. We see further optionality from accretive acquisitions given growing debt headroom.

### Share price performance

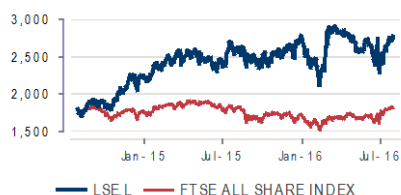

The price relative chart measures performance against the FTSE ALL SHARE INDEX which closed at 3653.8 on 29/07/16  
On 29/07/16 the spot exchange rate was £.84/Eu 1.-  
Eu.9/US\$1

Performance	1M	3M	12M
Absolute (%)	11.4	2.3	7.1
Relative (%)	5.2	-4.5	6.5

### Financial and valuation metrics

Year	12/15A	12/16E	12/17E	12/18E
Revenue (£ m)	1419.1	1581.4	1694.3	1795.0
EBITDA (£ m)	644.11	771.28	878.56	964.94
Pre-tax profit adjusted (£ m)	516.91	646.40	753.32	837.22
CS EPS (adj.) (p)	103.52	128.63	150.85	168.17
Prev. EPS (p)	-	-	-	-
ROIC (%)	12.26	14.48	16.62	18.33
P/E (adj.) (x)	26.81	21.57	18.40	16.50
P/E rel. (%)	163.2	124.5	122.9	124.8
EV/EBITDA (x)	15.8	12.9	11.0	9.7
Dividend (12/16E, p)	40.6	IC (12/16E, £ m)		3,628.6
Dividend yield (12/16E, %)	1.5	EV/IC (12/16E, (x)		2.8
Net debt (12/16E, £ m)	213.8	Current WACC (%)		8.5
Net debt/equity (12/16E, %)	6.3	Free float (%)		98.6
BV/share (12/16E, £)	8.5	Number of shares (m)		350.3

Source: Company data, Thomson Reuters, Credit Suisse estimates



## Japan Exchange Group (8697)

Rating	<b>UNDERPERFORM</b>
Price (29 Jul 16, ¥)	1,470
Target Price (¥)	995
Chg to TP (%)	-32.3
Market cap (¥ bn)	807.13 (US\$ 7.80)
Number of shares (mn)	549.07
Free float (%)	85.0
52-week price range	2,198–1,116

\*Stock ratings are relative to the coverage universe in each analyst's or each team's respective sector.  
†Target price is for 12 months.

### Research Analysts

**Takehito Yamanaka**  
81 3 4550 9150  
takehito.yamanaka@credit-suisse.com

**Kenya Goto**  
81 3 4550 7372  
kenya.goto@credit-suisse.com

## Blockchain: likely to have more impact on the overall securities industry than exchanges

■ **Proactively pursuing PoC tests:** We met with Mr. Atsushi Santo, Head, Fintech Laboratory, Japan Exchange Group (JPX). JPX looks set to complete two proof of concept (PoC) tests of blockchain systems as it conducts comprehensive studies to evaluate the potential, and also limitations, of the technology. Currently JPX is testing blockchain technology in the most frictional markets and business.

■ **Little financial incentive at present:** JPX is of the view that given securities-trading infrastructure requirements, it will be hard to eliminate third-party mediators/repositories in the Japanese market. The necessity of third-party mediators and a range of other requirements mean that costs are unlikely to fall sharply. While this means new entrants in the securities exchange business are unlikely to present a meaningful threat to JPX, we think their efforts to engage with and test blockchain technology may offer the potential for future opportunities.

We believe that given its current position within Japan, JPX is best placed as a third-party mediator/repository in the securities business.

■ **Future opportunities to expand business scope:** As outlined above, the execution function has become increasingly high-speed, but business models for process layers other than securities transactions have evolved more slowly. We think that, regulations permitting, further integration in peripheral businesses could enable JPX to expand operations.

■ **Maintain Underperform:** We recently reiterated our Underperform rating given weak June data and cut our target price from ¥1,160 to ¥995 (-32% downside). Valuations are reverting to a level justified by profits, but this is coming in tandem with increasing investor pessimism on where trading volume—the key profit driver—is headed (full note [here](#)).

### Share price performance

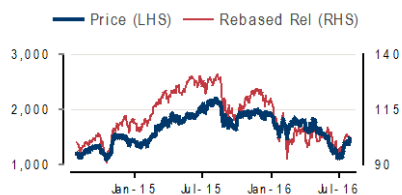

The price relative chart measures performance against the TOPIX which closed at 1,322.74 on 29-Jul-2016  
On 29-Jul-2016 the spot exchange rate was ¥103.54/US\$1

Performance	1M	3M	12M
Absolute (%)	29.1	-12.3	-31.8
Relative (%)	23.0	-11.0	-12.1

### Financial and valuation metrics

Year	3/16A	3/17E	3/18E	3/19E
Operating Revenue (¥ bn)	116.9	110.5	115.8	120.5
Earnings before tax (¥ bn)	67.8	58.5	63.6	64.9
Net profit (¥ bn)	44.9	40.7	44.2	45.0
EPS (¥)	81.7	74.1	80.5	82.0
IBES Consensus EPS (¥)	n.a.	68.0	67.6	86.9
EPS growth (%)	(34.8)	(9.3)	8.6	1.8
P/E (x)	21.7	19.8	18.3	17.9
Dividend yield (%)	2.8	3.1	3.3	3.4
BPS (¥)	468.4	509.8	547.5	514.5
P/B (x)	3.8	2.9	2.7	2.9
ROE (%)	18.2	15.2	15.2	15.4

Source: Company data, Thomson Reuters, Credit Suisse estimates



# US Exchanges

## Analyst View

### Research Analysts

**Christian Bolu**  
212 538 9805  
christian.bolu@credit-suisse.com

**Richard Fellinger**  
212 325 7909  
richard.fellinger@credit-suisse.com

### Implications of Blockchain Technology

- **Post Trade Applications Most Likely.** We largely agree with the view that post trade processes like settlement and custody offer the most feasible use case for blockchain technology. In our view current execution and derivatives central clearing (CCP) venues are less likely to be disrupted given challenges around transaction speed (see LSE: Blockchain – more opportunity than threat) and regulation (see below). That said, industry efforts to adopt blockchain technology are at the very least likely to drive greater post trade standardization thus reducing friction and operational risk in the settlement process. As a result, we view blockchain as more of an opportunity than a risk for the vertically integrated models of the US derivatives exchanges (CME & ICE).
- **Regulation Presents a Significant Hurdle.** Even when we move past the challenges of the technology, standards and adoption, there is also the fact that the financial services industry is highly regulated, particularly for clearing where regulation has pushed derivatives volumes toward central counterparties (CCP). Even in a world where bitcoin technology allows near real-time transaction settlement (theoretically removing the need for a central counterparty) CCPs for derivative products will be needed to achieve netting and reduced future counterparty credit risk. Perhaps one positive of regulation is it makes it highly unlikely a startup will be able to side-step current market participants when creating a solution – providing another layer of protection for the exchanges.
- **Cryptocurrency Trading—A New Trading Asset Class?** We see the trading of cryptocurrencies (such as bitcoin) as a potential opportunity for exchanges. While the current market for cryptocurrencies is very small (~\$15bn 'market capitalization') and largely driven by speculative retail activity, the longer term addressable market could be significant to the extent these currencies are more widely adopted in the payment global system. Key to the professionalization of cryptocurrency trading will be robust reference pricing with independent oversight. To this end, we see the NYSE bitcoin index (launched in 2015) and the impending launch of bitcoin reference rates and real-time price index on the CME group (expected in 4Q2016) as key innovations—the potential listing of bitcoin derivatives being a logical next step.
- **Exchanges Have Positioned Themselves to Avoid Disintermediation.** With so much still unknown, the exchanges are mostly making seed investments to ensure they are on top of the trends and will be part of any solution. CME for example has CME Ventures, a group that invests in companies that could be important to them in the long run, and blockchain is just one of many. ICE was one of the earliest firms to signal an interest in the industry, including investing in bitcoin services firm Coinbase as part of its \$75m Series C funding round in 2015.

## NASDAQ Group Inc. (NDAQ)

Rating	<b>OUTPERFORM</b>
Price (29-Jul-16, US\$)	71.08
Target price (US\$)	72.00
52-week price range	71.08 - 48.84
Market cap (US\$ m)	11,693.70

\*Stock ratings are relative to the coverage universe in each analyst's or each team's respective sector.

†Target price is for 12 months.

### Research Analysts

**Ashley N. Serrao, CFA**

212 538 8424

ashley.serrao@credit-suisse.com

**Marcus Carney**

212 325 1442

marcus.carney@credit-suisse.com

## An early blockchain adopter

- Current implementation in NASDAQ Private Markets (NPM):** NDAQ has been an early adopter of blockchain, deploying the underlying bitcoin technology across various initiatives. With that said, it's still early days and the revenue contribution is yet to be meaningful, but the applications have shown plenty of promise. With their 2015 implementation of Linq, NASDAQ became the first major global stock exchange to publicly trial blockchain technology. Linq uses blockchain to complete and record transactions of private securities on Nasdaq Private Market. Historically, record keeping of the private shares trading process has relied on pen-and-paper or spreadsheets; the transition of these highly manual, error-prone processes to a platform backed by blockchain improves standardization and transparency while providing an opportunity for Nasdaq to leverage this technology outside of NPM.
- Proxy voting:** In early 2016, Nasdaq announced their second use case—a blockchain backed e-voting proxy solution in Estonia catered to shareholders of companies listed on the Nasdaq OMX Tallinn Stock Exchange (Estonia's only regulated securities market). Nasdaq's blockchain initiative here has allowed proxy voting, a historically labor-intensive and fragmented process, to become more convenient, secure and frequent as shareholders participate in corporate governance.

### Share price performance

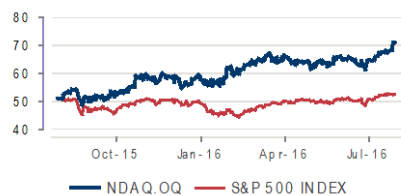

On 29-Jul-2016 the S&P 500 INDEX closed at 2171.96  
Daily Jul30, 2015 - Jul29, 2016, 07/30/15 = US\$50.99

Quarterly EPS	Q1	Q2	Q3	Q4
2015A	0.80	0.83	0.88	0.89
2016E	0.91	0.91	0.95	1.01
2017E	-	-	-	-

### Financial and valuation metrics

Year	12/15A	12/16E	12/17E	12/18E
EPS (CS adj.) (US\$)	3.40	3.78	4.26	4.55
Prev. EPS (US\$)	-	-	-	-
P/E (x)	20.9	18.8	16.7	15.6
Relative P/E (%)	113	102	103	108
Revenue (US\$ m)	2,090.0	2,292.7	2,470.9	2,557.5
Pre provision Income (US\$ m)	977	1,072	1,193	1,252
Book Value (US\$)	32.74	34.85	35.64	36.31
Tangible book value (US\$)	-10.19	-18.58	-17.41	-16.81
ROE (%)	10.2	11.1	12.1	12.6
ROA (%)	6.10	6.19	6.43	6.84
Book Value (Next Qtr., US\$)	34.33	Tangible BV (Next Qtr) (US\$)		-19.06
P/BV (x) (Next Qtr.)	2.1	P/TBV (Next Qtr) (x)		-3.7
Dividend (Next Qtr) (US\$)	1.28	Shares Outstanding (m)		165
Dividend yield (%)	0.8			

Source: Company data, Thomson Reuters, Credit Suisse estimates

- **Changing the post-trade landscape.** While management doesn't expect blockchain to help tick-by-tick trading, we see opportunity for the technology to reduce friction across the entire trading lifecycle, from private placement (an area ripe for innovation given incredible efficiencies) to IPOs to post-trade solutions. Management is particularly upbeat on the post-trade opportunity, and we concur—an open blockchain database would ensure that users, members, regulators, banks, brokers and clearinghouses all see exactly the same data validated at exactly the same time, removing the need for reconciliation. We believe Nasdaq will be able to further reduce post-trade settlement frictions given the company's focus of integrating blockchain as a service into their core platform (we expect this will facilitate transfer of ownership of assets and support a shortening of t+3 settlement periods).
- **Scalability is key, but challenges persist.** Considering that the core technology driving Nasdaq's innovation is proprietary (giving them control, scale and leverage of initiatives), we are constructive on the company's potential to scale their blockchain initiatives across applications, regions and business lines. Management views blockchain as a central component of the Nasdaq Financial Framework (the company's harmonized end-to-end solutions to financial infrastructure providers globally), but note that integration remains a key challenge. Nasdaq's clients come from myriad backgrounds, market structures and regulatory environments, each presenting unique challenges. We view the company's role as both a provider (to clients) and applier (within their own systems) of blockchain solutions as a step in the right direction, allowing management to implement key features and recognize limitations.

Research Analysts

Karl Green  
44 20 7888 2629  
karl.green@credit-suisse.com

## UK Business Process Outsourcing service providers

### Summary

**Share registration:** The application of blockchain technology to the UK share registration market is at least five years away, in our view. It is likely that full dematerialisation (the eradication of physical share certificates) needs to happen before full adoption can happen, and the timing of this is deeply uncertain. In the event of a shift to blockchain, we believe there will still be a critical permissioned 'gatekeeping' function for the incumbent registrars to ensure that all entries onto the chain and reconciliations of data being pulled from the chain are accurate and to act as the ultimate 'source of truth' as regards legal title. We see the threat of disintermediation as a relatively low probability risk.

**Payments:** Capita and Equiniti are the two largest pensions payments administrators in the UK, handling billions of pounds worth of transactions each year. The potential for blockchain to remove significant layers of cost from the current 'byzantine' UK payments architecture could deliver significant cost savings for Business Process Outsourcing (BPO) operators. We believe the timing of this potential opportunity is likely to precede the timing of any disintermediation threat in share registration.

**Public sector opportunity:** The UK government has already identified significant and wide-ranging benefits of distributed ledger technology to public sector administration. This could create a multi-decade opportunity for blockchain transition and integration specialists. Capita and Equiniti are likely to have to partner and acquire to build the skills to meet the demand. Once any such grand project has been achieved it is unclear what the size and shape of the UK public sector BPO will look like over the very long term, but this is likely offset by a significant opportunity to export such skills internationally.

### Share registration

As highlighted in Figure 72 (Structure of the capital markets ecosystem), the post trade environment is crowded. Blockchain technology could, in our view, create scope for the elimination of superfluous functions along with potential vertical integration of the remaining functions/legally mandated registrations and notifications in the settlement process.

**Figure 80: UK shareholder registration & corporate actions market share (2014)**

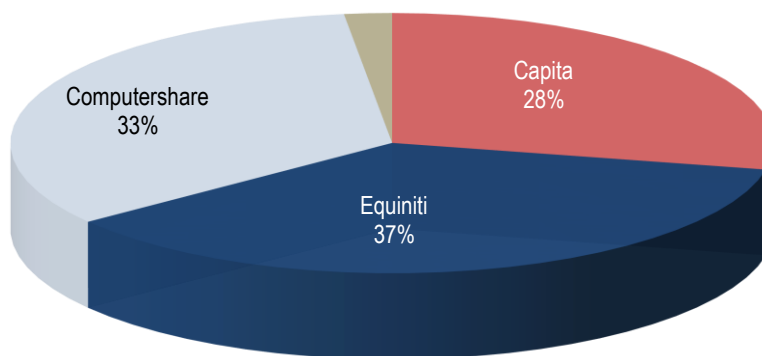

Source: Credit Suisse estimates

The UK share registration market is dominated by three players – Equiniti, Capita and Computershare, with broadly comparable market shares, as shown in Figure 80. Given the pioneering blockchain R&D being undertaken in Australia by ASX and Computershare, investors are keen to understand whether this disruptive technology could be exported to the UK.

Two of the dominant players in UK share registration, Capita and Equiniti, are listed on the London stock market and are classified as Business Services companies, although in reality both companies share much in common with technology companies. Share registration forms only a relatively small part of each group's activities (see Figure 81 to Figure 84) and both companies have a broad portfolio of BPO, consulting and software-related activities. Equiniti has a greater proportionate exposure compared to Capita with around 3x the level of profit exposure (noting that share registration is a high profitability activity for both companies, due to market concentration and inherent scale efficiencies.)

However, as part of both companies' third party administration services provided to both public and private sector customers, the companies handle a vast array of transactions and processes which require the use of large scale databases, integrated software and interfaces with other third-party transaction process facilitators, such as payment process providers.

In our view, the potential direct and indirect applications of blockchain to the activities and wider ecosystems of BPO providers go beyond their share registration activities (albeit that share registration could be an early adopter of the technology). This could present new revenue and cost efficiency opportunities, as well as potentially challenging the structure of or requirement for current processes which currently generate revenues for the BPO sector.

**Figure 81: EQN core share registration as % of group revenues (2016E)**

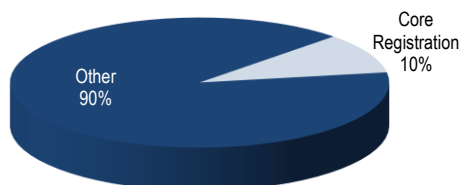

Source: Credit Suisse estimates

**Figure 82: EQN core share registration as % of group EBITA (2016E)**



Source: Credit Suisse estimates

**Figure 83: CPI share registration as % of group revenues (2015E)**

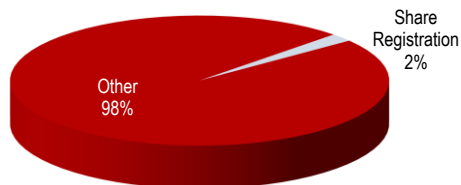

Source: Credit Suisse estimates

**Figure 84: CPI share registration as % of group EBITA (2015E)**

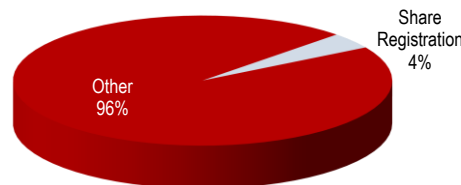

Source: Credit Suisse estimates

**Australia taking the lead**

At present the debate as to whether blockchain technology can be applied commercially to share registration is being led out of Australia where, as Computershare noted in its April 2016 capital markets presentation, "(There is) *some market speculation about how ASX will leverage blockchain technology to move downstream into "issuer agent" services role. The rationale cited is to offset loss of clearing revenue from competition.*"

This has led some UK investors to question whether there is a long term risk that registrars could be supplanted by a lower cost/more efficient system or disintermediated altogether. We believe that this longer-term risk has the potential to affect the rates of terminal growth and/or sustainable returns on capital assumed and embedded in long-term

DCF analysis (and implicit in the low P/E rating of Equiniti, which trades at just 11x 2017E P/E).

Before considering the specific UK situation, it is worth noting some of Computershare's key contentions from its capital markets event which resonate with many of the observations made by Equiniti, with whom we have had detailed engagement on the topic.

- In Computershare's view, the share register and the ledger are highly complementary but serve different purposes.
- CPU does not believe a distributed ledger would constitute the "share register" for corporate law, privacy reasons or operational purposes (noting that, in Australia, the legal register of title is already deemed "the single source of truth").
- CPU views the distributed ledger as a sophisticated transaction communications channel between different actors in the market system. Access rules and commercial dynamics determine who plays what roles for whom on the ledger.
- CPU believes that there are sound and effective regulatory policy reasons why connecting the register to the distributed ledger will deliver a more effective regulatory outcome based on trusted service providers.

In this respect, the potential shift from a 4-level to a 2-level architecture (as highlighted in Figure 74, "Opportunity for vertical integration") appears to be the most likely outcome over time since the *raison d'être* for share registry would persist in the form of the obligations of an issuer to maintain an accurate picture of disparate legal title, reporting & communications, transfer processing, administration of dividend payments and corporate actions (e.g. stock splits, M&A and demergers).

### When might the UK follow suit?

In the context of the UK, we believe that the core issue of title (i.e. the extent to which an alternative data record to a shareholder register could constitute legal title to securities or other intangible assets) is a highly complex subject.

In our view, we believe that significant primary and secondary legislative change would be required, specifically modifications to the Companies Act 2006, which came into force in 2009. (Note that one of the main components of the 2006 Act was the enablement of the electronic fulfilment of many company duties, including submissions and communications with shareholders.) Given that UK lawmakers are likely to be heavily distracted by Brexit negotiations for the foreseeable future, we think any proposed changes are unlikely to feature high up the legislative agenda.

One of the other uncertainties around the timing of any shift towards a distributed ledger model is whether the ongoing existence of physical share certificates in the UK market would be compatible with a blockchain driven system in terms of the inefficiencies of having on and off-chain administration and reconciliation mechanisms.

As law firm Linklaters (6<sup>th</sup> June 2013, link [here](#)) summarises, "*Currently UK shares can be traded and held in either dematerialised form (through CREST) or in certificated form (on a traditional register, with paper certificates being issued). The [European] CSD regulation will require all securities which are traded on regulated markets or multilateral trading facilities (MTFs) to be dematerialised. This means that it will no longer be possible for shareholders of traded companies to hold their shares in certificated form.*"

The CSD regulation referred to currently proposes full dematerialisation from 2023/2025 (new issues/all outstanding issues), from which point the UK would in theory be fully digitised and, like Australia, would thus potentially be better placed to make the switch to a blockchain-based system. Post-Brexit, however, there is now uncertainty around timing of dematerialisation:

- Depending on the outcome of Brexit negotiations (which are likely to be heavily influenced by the desire to retain passporting rights for the UK's large and economically important financial services industry), it is not clear that the dematerialisation regulations will definitely come into force in the UK. There are a number of objections to the dematerialisation drive from individual shareholders who lose a number of non-financial beneficial rights from being effectively forced to hold stock through a broker's nominee account, including the rights to vote in and attend the AGM, receive the report and accounts and other shareholder perks which some companies still offer to direct shareholders.
- On the other hand, according to Capita Asset Services' recent article entitled, 'Brexit – the practical impacts on business law and regulation', "*Industry bodies have been lobbying for implementation of dematerialisation to be brought forward to 2018 (from the regulation requirement of 2023/2025). This approach may need to be revised in the light of the referendum outcome however dematerialisation within the UK is still a goal that should be pursued, given the benefits for share trading and ownership.*

Therefore, if indeed dematerialisation is accelerated, irrespective of any European mandate, this would also reduce the obstacles to a transition to blockchain-based model. Indeed, if the City of London is forced to compete more aggressively on a global basis to retain its position as a pre-eminent centre for capital markets access (for example, in the event of an unfavourable settlement with Brussels), an acceleration of innovation may well be encouraged by legislators as a way of preserving tax revenues from this hitherto important industry.

On this basis, whilst our Australian colleagues believe that there is unlikely to be any impact from blockchain on Computershare for at least three years "and even then it will be very staggered", we believe that it is likely to take even longer to have a material effect on the UK registry market, possibly closer to 10 years.

### **'Gatekeeper' function likely to be required**

In our view, we think the most likely scenario in the UK will be for registrars to act as gatekeepers to the blockchain on behalf of issuers in terms of being the trusted partner to the company chairperson and company secretary to ensure that all entries onto the chain and reconciliations of data being pulled from the chain are accurate, timely and comply with both regulatory requirements and those of a company's own articles of association.

Specifically, in terms of the final stage between the absolute verification of a shareholder's identification and their 'on-block' alphanumeric crypto-ID, we believe that there is likely to be material public pressure to ensure a very high level of data security in terms of the interface between on and off-chain information.

For example, all of Equiniti's databases are currently held onshore in the UK and are 'air-gapped' which means that Equiniti's secure network is physically (or digitally, via dedicated cryptography) isolated from unsecured networks such as the public internet or unsecured local area networks. The prevention of hacking of sensitive personal information is already business-critical for database managers such as Equiniti and Capita and we believe that registrars are in a naturally strong position to be entrusted to guard the bridge between sensitive 'real world' information and a public digital repository which could be viewed by consumers, regulators and politicians alike as something of a 'wild west' for many years.



## Payments administration

One feature of the BPO industry is that payments administration is a core task which is often bundled into larger contracts (e.g. Capita's £1bn, 7-year NHS primary care support contract to run a variety of back office services including payments administration and the management of clinical records) or form the bedrock of responsibilities in markets such as pensions administration (noting that Capita and Equiniti are the two largest third-party administrators in the UK, responsible for billions of pounds of payments to individuals each year).

As discussed elsewhere in this report, the opportunity to simplify payment handling processes in the UK and elsewhere has the potential to remove significant layers of inefficiency which the CEO of Equiniti has described as "byzantine". Direct settlement via distributed ledger technology has the potential to largely eradicate the current electronic processing cost embedded in current payment systems, estimated to be in the region of £250m annually in the UK alone. Figure 85 below highlights the process flow embedded in the UK CHAPS system (which processes payments the same working day).

**Figure 85: The multi-layered CHAPS payments system in the UK**

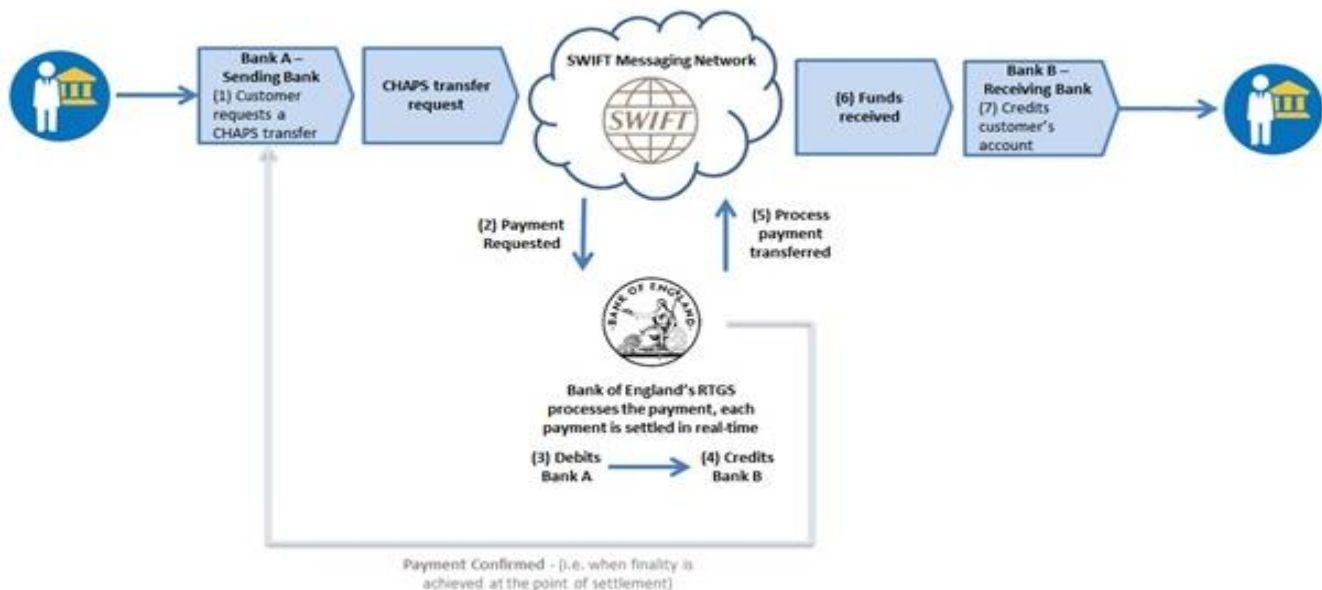

Source: CHAPS Co (System Operators for CHAPS Clearing Company Ltd)

Note that CHAPS is just one system in place in the UK. Another example would be the BACS system which takes three days to reach a recipient's bank account via 'umbrella' companies, highlighting the multiple routes and potential duplication of reporting and systems interfaces.

Clearly the shift to an almost frictionless system could significantly lower transaction costs for BPO companies and other users of the payments system. Based on our conversations with the industry, we believe the cost savings could be very significant and for Capita, we estimate the cost savings could run to double-digit millions of pounds. One of the questions will be the extent to which customers may expect to have this saving passed through to them, which is especially pertinent in the pensions administration market where there is significant pressure to reduce costs as funds battle with very challenging capital markets to discharge their liabilities and responsibilities.



It seems likely, given the desire of banks to lower their costs, that blockchain technology will be applied to the payments ecosystem before a commercial application arises in the share registry market and could therefore be supportive for EBITA margins in the medium term.

## Other applications

Whilst it is clear that the primary focus of blockchain innovation for the foreseeable future will be in the sphere of financial services and transaction processing, over the long term there are a myriad of potential applications to the broader private sector, public sector and possibly even the charitable sector. The public sector is of particular relevance to Capita which derives just under half of group revenues from the UK public sector across a wide range of central and local government relationships.

### **The UK public sector looks set to be a pioneer in blockchain adoption**

The UK's Government Office for Science has published a particularly prescient paper on the topic, entitled 'Distributed Ledger Technology: beyond blockchain' which notes that, "The UK Government Digital Service is developing a digital platform for government to deliver its services and distributed ledgers could be at the heart of this." The potential applications to which distributed ledger technology (to which the Office for Science refers as 'DLT') identified in the report include the following:

- Collection of taxes and the payment of benefits
- The issuance of passports and driver's licenses
- The creation of a single record of ID (vs. the current system of four separate databases – HMRC, Passport, NHS and National Insurance)
- A DLT-based land registry
- Supply chain assurance
- Fortification of the integrity of government records and services
- Improvement and authentication of health records + protocols on record sharing
- The potential for citizens to control access to personal records and know who has accessed them

The implications of this, if ever implemented, could be profound in terms of the eradication of bureaucracy and the acceleration of process speeds. On the one hand this could present a huge opportunity for consultants and BPO providers on a multi-decade view to help the government and all its organs to make the transition to a 'nirvana' of secure, accurate and relatively frictionless data and processes.

However, on the other hand, over the very long-term it begs the question as to exactly what processes will require any significant level of third-party administration (especially if developments in the artificial intelligence market transform the delivery of customer contact management, but that is a topic beyond the remit of this report).

By this stage we are more into the realms of crystal-ball gazing, rather than analytical assessment, but it raises the intriguing question as to exactly what Capita might look like in 20 years' time. One would hope that Capita has morphed into a strong digital infrastructure partner for its clients in the UK and overseas, but there is also a risk that it gets outcompeted or absorbed into a larger entity. Either way the potential seismic shift in Capita's core market makes it that little bit harder to have confidence in the long-term sustainable growth and returns profile.

### **The application of blockchain-like systems to the public sector has already happened in some areas**

According to the UK Office for Science, the Estonian government has been experimenting with distributed ledger technology for a number of years using a form of distributed ledger technology known as 'Keyless Signature Infrastructure' (KSI) which pairs cryptographic functions with a distributed ledger. According to the report, "*KSI allows citizens to verify the integrity of their records on government databases. It also appears to make it impossible for privileged insiders to perform illegal acts inside the government networks. This ability to assure citizens that their data are held securely and accurately has helped Estonia to launch digital services such as e-Business Register and e-Tax.*"

The report also notes from a security perspective that, "*the KSI block chain means that while the Estonian ID Card may never be immune to a breach (although there have been none so far), the government is assured that rogue alterations to public data will be 100% detectable*".

Encouragingly, the UK is a member of the 'Digital 5' or D5 group of nations, of which the other members are Estonia, Israel, New Zealand and South Korea. There are thus opportunities for the UK to collaborate with other pioneering nations to become an early adopter of this technology in the public sector.

Given Capita's strong ties to many agencies in the UK Government, this could in theory allow the group to become a globally pre-eminent force in blockchain integration projects. However, this assumes that the group is able to build the right blockchain skill base and tech platforms both organically and via M&A/joint-venturing. On the basis that DLT, to our knowledge, has not been *specifically* mentioned as a potential area of focus by senior management (though one could argue that it is implicit in the digitisation strategy), it would seem for now that Capita's largest (collective) customer is currently ahead of the game.

## Equiniti (EQN.L)

Rating	<b>OUTPERFORM [V]</b>
Price (29 Jul 16, p)	173.00
Target price (p)	210.00
Market Cap (£ m)	519.0
Enterprise value (£ m)	766.3

\*Stock ratings are relative to the coverage universe in each analyst's or each team's respective sector.

†Target price is for 12 months.

[V] = Stock Considered Volatile (see Disclosure Appendix)

### Research Analysts

**Karl Green**

44 20 7888 2629  
karl.green@credit-suisse.com

**Andy Grobler, CFA**

44 20 7883 5943  
andy.grobler@credit-suisse.com

**Daniel Hobden**

44 20 7883 3290  
daniel.hobden@credit-suisse.com

## On the front foot

- **Blockchain could be a net opportunity for EQN:** Our analysis suggests that the evolution of distributed ledger technology (blockchain) could represent a net positive for the Equiniti equity story over the medium to longer term. We believe there will still be a critical function for independent share registrars in the event of any move towards blockchain and that other parts of the EQN portfolio could benefit from simplified processes and lower costs. We believe that, as EQN's R&D and forward thinking around blockchain becomes more widely appreciated, the stock's discount to the wider sector should diminish and we thus reiterate our Outperform stance.
- **Disintermediation threat far from certain:** We believe the application of blockchain technology to the UK share registration market is at least 5 years away and that full 'dematerialisation' of shares is a likely prerequisite. A critical permissioned 'gatekeeping' function is still likely to be required to ensure that all entries onto the chain and reconciliations of data being pulled from the chain are accurate and to underpin legal title. In our view, this is likely to favour incumbent registrars and we see the threat of disintermediation as a relatively low probability risk. Independently, any blockchain-led redesign of the UK's 'byzantine' payments architecture could reduce friction in the system and, more tangibly, EQN's operating costs. We believe any such change would likely precede any upheaval in the securities post-trade settlement and registration environment.
- **Catalysts:** The date for the group's Q3 results is TBC (likely Oct/Nov).
- **Valuation:** We believe that one of the reasons why EQN trades at a low absolute P/E multiple (and at a material discount to the wider sector) is due to investors' growing awareness of the disruptive potential of blockchain across a wide range of financial services functions. Our 210p TP is already predicated on a significant fade in returns over the long-term and we believe that any adverse NPV impact arising from blockchain is likely to be limited given the significant legal and regulatory hurdles to be overcome in the UK.

### Share price performance

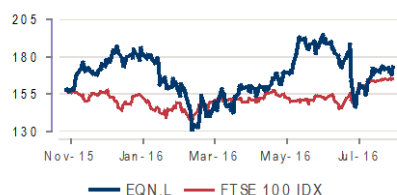

The price relative chart measures performance against the FTSE 100 IDX which closed at 6724.4 on 29/07/16. On 29/07/16 the spot exchange rate was £.84/Eu 1.- Eu.9/US\$1

Performance	1M	3M	12M
Absolute (%)	10.9	1.9	
Relative (%)	5.2	-5.8	

### Financial and valuation metrics

Year	12/15A	12/16E	12/17E	12/18E
Revenue (£ m)	369.0	389.3	405.0	423.0
EBITDA (£ m)	86.2	91.5	96.0	101.0
Pre-tax profit adjusted (£ m)	5.30	57.88	64.00	70.04
CS EPS (adj.) (p)	12.74	14.24	15.90	17.57
Prev. EPS (p)	-	-	-	-
ROIC (%)	10.5	9.2	10.3	11.5
P/E (adj.) (x)	13.6	12.1	10.9	9.8
P/E rel. (%)	82.6	70.1	72.7	74.5
EV/EBITDA (x)	8.9	8.4	7.5	6.7
Dividend (12/16E, £)	4.60	Net debt/equity (12/16E,%)		70.2
Dividend yield (12/16E,%)	2.7	Net debt (12/16E, £ m)		248.2
BV/share (12/16E, £)	1.1	IC (12/16E, £ m)		602.0
Free float (%)	80.0	EV/IC (12/16E, (x))		1.3

Source: Company data, Thomson Reuters, Credit Suisse estimates

## Capita (CPI.L)

Rating	<b>NEUTRAL</b>
Price (29 Jul 16, p)	960.00
Target price (p)	900.00
Market Cap (£ m)	6,403.6
Enterprise value (£ m)	8,563.7

\*Stock ratings are relative to the coverage universe in each analyst's or each team's respective sector.  
†Target price is for 12 months.

### Research Analysts

<b>Karl Green</b>
44 20 7888 2629
karl.green@credit-suisse.com
<b>Andy Grobler, CFA</b>
44 20 7883 5943
andy.grobler@credit-suisse.com
<b>Daniel Hobden</b>
44 20 7883 3290
daniel.hobden@credit-suisse.com

## DLT may one day define UK public sector BPO

- **Share registration risks a red herring for CPI:** As a member of the UK share registration oligopoly and, given the rhetoric around potential blockchain developments in the Australian securities market, investors may be prone to focusing on threats to CPI's share registration business. However, we estimate this accounts for only c.4% of group EBITA (and, in any event, see disintermediation risks as low). Instead, we see a combination of opportunity from the potential redesign of the UK payments architecture and a plethora of questions about the role of the BPO industry in a public sector administration rebuilt on distributed ledger technology (DLT).
- **The UK government sees huge potential in blockchain:** The UK's Office for Science has already identified significant and wide-ranging benefits of distributed ledger technology to public sector administration. This could create a multi-decade opportunity for blockchain transition and integration specialists, but begs the question what UK public sector BPO, which accounts for just under half of CPI's revenues, will look like in the very long term. It is unclear whether CPI will be able to build organically or acquire the skills required to be a winner under this new paradigm, or indeed at what cost. However, as a current top BPO supplier to the UK Government which aspires to be a pioneer in DLT-based public sector admin globally, CPI may correspondingly be positioned to develop a globally preeminent capability.
- **Catalysts:** CPI is due to issue a year end trading update in early December.
- **Valuation:** CPI is currently trading towards the bottom end of its historic valuation range as the market is concerned about a potential extended hiatus in the group's public sector contract awards due to Government distractions around Brexit. Pre Brexit, we believe SotP analysis suggested that the group's Asset Services division implicitly carried a small, but tangible blockchain valuation discount. The longer term net impact of blockchain on the broader business model is, at present, too uncertain to quantify. We maintain our Neutral rating.

### Share price performance

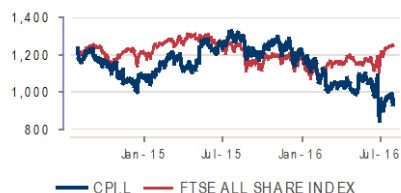

The price relative chart measures performance against the FTSE ALL SHARE INDEX which closed at 3653.8 on 29/07/16  
On 29/07/16 the spot exchange rate was £.84/Eu 1.-  
Eu.9/US\$1

Performance	1M	3M	12M
Absolute (%)	2.1	-4.1	-24.9
Relative (%)	-4.0	-10.9	-25.5

### Financial and valuation metrics

Year	12/15A	12/16E	12/17E	12/18E
Revenue (£ m)	4,836.9	4,839.1	4,703.3	4,836.3
EBITDA (£ m)	734.3	756.1	746.7	776.5
Pre-tax profit adjusted (£ m)	153.10	418.85	421.66	450.83
CS EPS (adj.) (p)	70.73	72.19	72.09	75.33
Prev. EPS (p)	-	-	-	-
ROIC (%)	4.2	12.7	12.4	13.0
P/E (adj.) (x)	13.6	13.3	13.3	12.7
P/E rel. (%)	82.6	76.7	88.9	96.4
EV/EBITDA (x)	11.9	11.2	11.0	10.2
Dividend (12/16E, £)	33.92	Net debt/equity (12/16E,%)		193.3
Dividend yield (12/16E,%)	3.5	Net debt (12/16E, £ m)		2,032.4
BV/share (12/16E, £)	1.5	IC (12/16E, £ m)		3,084.0
Free float (%)	100.0	EV/IC (12/16E, (x))		2.7

Source: Company data, Thomson Reuters, Credit Suisse estimates

# Computershare (CPU.AX / CPU AU)

Rating	<b>OUTPERFORM</b>
Price (29-Jul,A\$)	8.88
Target Price (A\$)	10.00
Target price ESG risk (%)	NA
Market cap (A\$m)	4,851.4
Yr avg. mthly trading (A\$m)	388.0
Projected return:	
Capital gain (%)	12.6
Dividend yield (net %)	3.6
Total return (%)	16.2

\*Stock ratings are relative to the relevant country benchmark.  
†Target price is for 12 months.

### Research Analysts

**Andrew Adams**  
61 2 8205 4106  
andrew.adams@credit-suisse.com

**James Cordukes, CFA**  
61 2 8205 4858  
james.cordukes@credit-suisse.com

## Blockchain presents opportunities, not just threats

- **Don't forget there is a 'bull' case.** Over the last year we have seen a flurry of negative press reports on CPU centred around the challenges that blockchain poses to their registry business. We see these concerns as somewhat overplayed with even our 'bear' case implying only a ~10-15% earnings impact. The commentary also fails to highlight some of the opportunities that blockchain could unlock for CPU, which under a 'bull' case could contribute as much as ~10-15% to earnings. Our bull case includes not only cost savings and new products but also opportunities in the US registry market if there were changes to shareholder ownership structure that unlocked Broadridge's dominance in 'street' name registry services.
- **Blockchain will not eliminate the registry function.** Rather a party is still required to act as the 'node' in a blockchain-based financial market infrastructure. While exchanges and banks may look to perform this function, we see it most likely to reside with the incumbents given the long term sticky nature of registry relationships and the unwillingness of new entrants to provide the labor intensive component of a full service registry offering.
- **Australia is the market most at risk.** To date, the analysis of the impact of blockchain on registry businesses has mostly focused on the Australian case, given Australia is a unique market. ASX is a fully integrated exchange which provides it with the catalyst to revisit its business as it re-builds its post-trade system and provides it with relationships with corporate issuers through its listings business. ASX also has a track record of being an innovative exchange and broadening its client base. Conversely, exchanges that focus solely on either trading or post-trade services (as in the US and Europe) are less likely to move into registry services, in our view.
- **CPU priced for the 'bear' scenario.** We believe CPU's share price is factoring the 'bear' case scenario with the stock currently trading on 13x 12 month forward earnings or a ~30% discount to the ASX200. We highlight that early stage blockchain technologies will not begin to impact CPU's business for another three years and even then it will be very staggered.

### Total return forecast in perspective

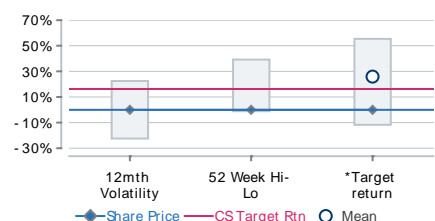

Source: Company data, Thomson Reuters, IBES, Credit Suisse estimates

Performance	1M	3M	12M
Absolute (%)	-3.16	-12.17	-27.98
Relative (%)	-11.33	-18.07	-26.09

### Financial and valuation metrics

Year	6/15A	6/16E	6/17E	6/18E
Revenue (US\$ mn)	1,976	1,956	2,043	2,094
EBITDA (US\$ mn)	554	520	508	553
EBIT (US\$ mn)	507	471	453	495
Net Income (Adj.) (US\$ mn)	333	304	281	302
EPS (Adj.) (USc)	59.82	55.08	51.13	55.03
Change from previous EPS (%)	n.a.	0.0	0.0	0.0
EPS growth (%)	(0.7)	(7.9)	(7.2)	7.6
Consensus EPS (USc)	59.60	54.70	55.80	59.50
P/E (x)	11.1	12.1	13.0	12.1
Dividends (Ac)	31.00	32.00	32.00	34.00
Dividend yield (%)	3.6	3.6	3.6	3.7
Price/Book (x)	3.2	3.2	2.9	2.7
Net debt/EBITDA (x)	2.2	2.4	2.2	1.7

Source: Company data, Thomson Reuters, Credit Suisse estimates

## Computershare (CPU.AX)

*"Computershare is an agent for a critical end-user segment of the market – an enviable position in a blockchain environment. We see real-life commercial opportunities given Computershare's unique positioning."*

*- Stuart Irving, Computershare CEO<sup>14</sup>*

### **A blockchain-based settlement service will still require a share registry function**

Over the last year we have seen a flurry of negative press reports on CPU centred around the challenges that blockchain poses to their registry business. We see these concerns as somewhat overplayed with even our 'bear' case implying only a ~10% earnings impact. The commentary also fails to highlight some of the opportunities that blockchain could unlock for CPU, which under a 'bull' case could contribute as much as ~10% to earnings.

Industries and companies most susceptible to disruption tend to be in intermediated industries and do not bear a close relationship with the end client within the value chain. While on one hand equity markets have a highly layered and intermediated value chain, CPU sits very close to the end consumer/investor within that system providing it with a somewhat insulated position than other segments of the value chain.

Ironically, blockchain poses more of a risk to exchanges than registry given it reduces the complexity of post-trade services and eliminates the need for clearing. There will still be a need for a share registry function, which will be one of the 'nodes' within a de-centralised ledger. The registry node will have permission to make additions to the ledger or blockchain and validate in-bound instructions/transactions. In this sense, the key question is 'who will perform the registry function?' in a blockchain world. As we shall explain, we see good reason that incumbent registrars will retain this role.

### **Some financial services firms may look to move along the value chain**

We do see risk of some financial services shifting along the value chain. Blockchain will require a large and broad-based upgrade of technology across financial services. While financial services firms have made the decision not to operate in the registry market up until this point, blockchain technology and the required upgrade to their technology platforms could be the catalyst that sees some revisit that decision.

We expect blockchain will initially result in significant cost savings (lower back office processing) for financial services firms, which are likely to be competed away in what are relatively competitive markets. As profits come under pressure and as IT platforms are rebuilt some financial services firms may look to use blockchain to expand their product offerings along the value chain and/or deliver new products and services.

Within the share registry market, we see exchanges and banks as the most likely to venture into the registry space. Exchanges face the risk of losing post-trade services revenues, yet through their listings business have relationships with corporate issuers to whom they could on-sell registry services. Alternatively, banks may see opportunities to cross-sell registry offerings given they have experience in communicating with retail investors (including administration) and have existing relationships with corporate issuers. We believe that banks and/or exchanges could also act as the registry node if they made sufficient investment in their IT platforms.

However, we think the registry function is more likely to continue to reside with incumbent registrars rather than shift to new participants. Registry relationships are long term, sticky relationships and over the last decade have shifted increasingly to packaged offerings including registry, shareholder communication, AGM and proxy services and employee share plan services. In this sense, unbundling registry services may not necessarily lead

<sup>14</sup> "Computershare chief rejects blockchain fears", Sydney Morning Herald (28 April 2016).



to cost savings for corporate issuers given competition is already very intense in the share registry market. Further, the registry function is serviced not only by a technology platform (which would be more willingly replicated by banks or exchanges) but also a rather labour-intensive call center which may be less appealing to potential new entrants.

### **Australia is the registry market most likely to come under threat**

Exchanges have been widely cited as the most likely to enter the registry market with ASX generally at the center of that discussion. We agree that ASX is perhaps the largest threat to CPU but likely for different reasons than are being mentioned currently. We believe that ASX poses the greatest risk due to circumstances specific to Australia including market structure and ASX's rather innovative culture. More generally, we believe the largest threat to share registrars will come from exchanges that control the full value chain, with Australia, some Asian markets and Canada all exhibiting those characteristics.

We see Australia as the largest threat for several reasons which we discuss below, most of them underpinned by the fact that ASX is an integrated exchange and operates under a monopoly market structure.

Exchanges that only offer trading services (and not clearing and settlement) – which includes quite a number of the US and European exchanges – are less likely to face the same pressure as those that offer post-trade services (the component of the value chain most likely to be impacted by blockchain). Exchanges that only offer trading services will not require the same investment as those offering post-trade services and so are less likely to reconsider their business models and services. Conversely, those offering post-trade services will need to invest heavily and while doing so may look to revisit their offering and consider expanding into registry.

Exchanges that only offer post-trade services are unlikely to have a relationship with corporate issuers. For these exchanges to sell registry services it will require them to establish new relationships. Conversely, fully integrated clearinghouses that also own the exchange will have an existing relationship with issuers as a result of their listings business. Therefore fully integrated exchanges, such as ASX, will be in a better position to cross sell share registry services. Integrated exchanges could also benefit from the ability to sell a packaged offering with discounts on annual listing fees for issuers that also provide the exchange with their share registry business.

Having made the case that the share registry business may be more appealing for integrated exchanges, we also note that ASX has a track record of innovative new products. ASX already offers an electronic sub-register of ownership as part of its CHES settlement system, which is potentially the only exchange in the world to do so (with the cost included in the settlement fee). ASX is also facing a low growth outlook (much lower than say the Asian exchanges where there is a strong growth outlook assisted by the liberalization of Chinese financial markets) and so is more likely to look for new opportunities to broaden its revenue base.

As such we see the Australian market as the biggest threat to CPU's registry business. Nevertheless, ASX may only choose to replace CHES with a new sub-register (similar to the current system) with CPU maintaining its position as the registrar.

CPU and other registrars have longstanding relationships with issuers which could be difficult for ASX to overcome. ASX is also unlikely to offer a full service share registry offering including labour-intensive call centres. This means any offering from ASX is likely to be technology based and more focused on small listed firms rather than CPU's core clients.

### Could banks shift into share registry?

At its Investor Day in April 2016 CPU argued that blockchain technology would not eliminate the registry function and that share registrars who were at the end of the value chain and had a relationship with the end investor were less likely to be disintermediated by disruptive technology. CPU envisioned a post-blockchain world where share registrars remained independent players and acted as the 'node' in the broader blockchain.

While we believe that CPU's view has merit, we could also see a scenario where those nodes are operated by alternative players. We think banks are one such alternative player. Banks would require a rather expansive technological overhaul if blockchain is to be adopted across the financial system. We imagine the incremental spend to also provide the registry function would be minimal in the overall cost. Banks already have many points of contact with retail customers and investors and could benefit from savings on payment processing. The banks will also have the ability to cross sell to corporate credit clients.

Ultimately this decision will depend on the path banks choose to take. The registrar market will provide them with further points of contact with customers, but banks may deem that 'administration' services are not their core business. Globally we have seen banks generally exit share registry and employee share plan businesses and so they may be reluctant to re-enter the market.

### The 'bull' and 'bear' cases for CPU

Press reports to date have focused on the 'bear' case scenarios for CPU. However, there is a 'bull' case. blockchain is a disruptive technology that will disintermediate and simplify complex markets and throw up new opportunities. Perhaps the greatest opportunity for CPU would be if the shareholder ownership structure in the US were to be overhauled and simplified (including Broadridge Financial's dominant position) which would present CPU with a significantly larger market opportunity in the US.

Blockchain will impact CPU's business in several ways including:

- *Threats and opportunities in existing business:* While CPU could come under threat in its existing markets from new entrants (as discussed earlier) blockchain may open up new opportunities (eg US).
- *Cost savings:* Blockchain will likely present CPU with cost savings through more efficient back office processing (albeit there will be an upfront investment cost). In addition efficiencies in the payments system will lead to lower transfer costs relating to dividend payments.
- *Lower margin income:* Advances in registry and payments as a result of blockchain will allow real-time dividend payment and could be a key catalyst for the shift away from payment of dividends using cheques (which is in itself declining). This would reduce CPU's margin balances and consequently its margin income.
- *New products and services:* blockchain would also underpin new products and services to registry clients, with data analytics services presenting the largest field of opportunity.

We believe there could be up/downside of +/-10% to CPU's earnings based on our bull/bear cases. However the earliest impacts are unlikely to be felt until FY20E with the full impact unlikely to be realized until FY25E or beyond. Our scenarios below present the potential impact in a decade as a portion of FY20E earnings.

While we have only conducted an earnings sensitivity, we note that gains or losses in income within the registry business could impact valuation by a greater amount given we think it is a high quality business deserving of a higher P/E.



**The 'bull' case**

Within our 'bull' case, we estimate there could be ~10% upside to CPU's earnings driven by deregulation / simplification of the US registry market, expense savings and new services. Within our scenario we have included a small reduction (~10%) in Australian registry which is the market most likely to come under threat as well as lower margin income (~10% reduction) from real time processing of dividends.

While the US market opportunity is at the more 'bullish' end of the spectrum, we believe there is a chance that blockchain could disrupt Broadridge's dominance in street name registry services. As background, in the US when shares are held directly (ie not within a mutual fund) they can be held by brokers – referred to as 'street' name share ownership – or by individuals – referred to as the 'non-street' market. Broadridge holds a monopoly over the 'street' name market which in turn accounts for 80-85% of total direct shareholdings in the US. CPU operates in the smaller non-street market (which accounts for 15-20% of directly held shares) where it has a leading market share (~60% of S&P500 companies). If blockchain were to lead to deregulation of share ownership including the elimination the 'street' and 'non-street' structure, then CPU's market could significantly increase. Within our 'bull' case we have assumed that CPU is able to penetrate this new market and grow its US registry business by 20% (which ironically would be a rather insignificant piece of Broadridge's business).

We have laid out the assumptions behind our bull case in the table below.

**Figure 86: CPU 'bull' case: ~10% EBITDA upside potential**

	EBITDA (US\$m)	% EBITDA
FY20E EBITDA	636.8	
10% reduction in Australian Registry / Corporate Actions EBITDA	(3.6)	(0.6%)
0% reduction in Global Registry / Corporate Actions EBITDA (ex Australia)	0.0	0.0%
20% benefit in US Registry / Corporate Actions due to deregulation	29.9	4.7%
10% reduction in Margin Income (relating to retained registry business)	(16.0)	(2.5%)
2.5% expense reduction	39.9	6.3%
2.5% EBITDA benefit from new services	15.9	2.5%
Pro-forma FY20E EBITDA	703.0	10.4%

Source: Credit Suisse estimates

**The 'bear' case**

Within our 'bear' case, we estimate that there is ~10% downside to earnings from blockchain, primarily driven by loss of business in Registry and lower margin income due to real time payment of dividends. We expect this to be modestly offset by expense savings and new services.

As we discussed earlier, we expect that the Australian registry market could face much greater pressure than other regions. As such we have assumed a 50% decline in the Australian registry business but only a 20% decline in the registry business in other regions. Within our estimates of the impact on the registry business we have also included the corporate actions businesses given it is closely associated.

We have laid out the assumptions behind our bear case in the table below.

**Figure 87: CPU 'bear' case: ~10% EBITDA downside potential**

	EBITDA (US\$mn)	% EBITDA
FY20E EBITDA	636.8	
50% reduction in Australian Registry / Corporate Actions EBITDA	(17.8)	(2.8%)
20% reduction in Global Registry / Corporate Actions EBITDA (ex Australia)	(49.1)	(7.7%)
0% benefit in US Registry / Corporate Actions due to deregulation	0.0	0.0%
15% reduction in Margin Income (relating to retained registry business)	(24.0)	(3.8%)
1.0% expense reduction	16.0	2.5%
1.0% EBITDA benefit from new services	6.4	1.0%
Pro-forma FY20E EBITDA	568.2	(10.8%)

Source: Credit Suisse estimates

**CPU priced for the 'bear' case**

We believe CPU's share price is factoring in the 'bear' case scenario, with the stock currently trading on 13x or a ~30% discount to the Australian market, which is below its long term average P/E of 16x and historical ~15% premium to the market.

While CPU is facing earnings headwinds and its business mix is shifting to arguably lower multiple businesses, we believe there is significant headroom in the valuation at this point in time to more than cover the downside risk of blockchain. It's unlikely that there will be any impact on blockchain for ~3 years and even then it will be very staggered. We expect Australia to be the first market that could be affected by blockchain with other markets to follow a number of years later.

Furthermore, while there may be downside earnings risk due to blockchain we note that there is also significant upside risk from higher interest rates over the next decade which is yet to be factored into earnings (eg a 100bp increase in rates would add ~US\$85mn to EBITDA, equivalent to a ~15% increase).

**CPU's investment in blockchain**

CPU is on the front foot when it comes to blockchain technology. It already has ~25 staff employed around the world working on the technology.

CPU has said they are currently working with clients on blockchain solutions citing their work with Overstock, which is preparing an issue of digital securities through blockchain back exchange. Overstock have engaged CPU from a registry perspective.

Further, CPU also announced a joint initiative with SETL (an institutional payment and settlement infrastructure based on blockchain technology) to establish a securities ownership register using blockchain technology. The CPU / SETL initiative will focus on the Australian market. The first steps are to examine the practicalities of a securities register using blockchain technology. CPU intends to engage key stakeholders to discuss an open platform to meet the needs of all participants.

# Analyst View

## Global Custodians

**Research Analysts**

**Ashley N. Serrao, CFA**  
212 538 8424  
ashley.serrao@credit-suisse.com

**Marcus Carney**  
212 325 1442  
marcus.carney@credit-suisse.com

Broadly, simplicity and transparency, which are the two key traits of blockchain, should lead to revenue pressures for the custodians. At the same time, the reality is the industry has yet to demonstrate economies of scale from asset gathering over the decades as expenses have proven to be more variable than fixed in nature. Consequently, we think the expense saves here will ultimately be meaningful, as arcane manual processes become automated.

**Figure 88: Stable Custody Market Share Indicates Minimal Economies of Scale**

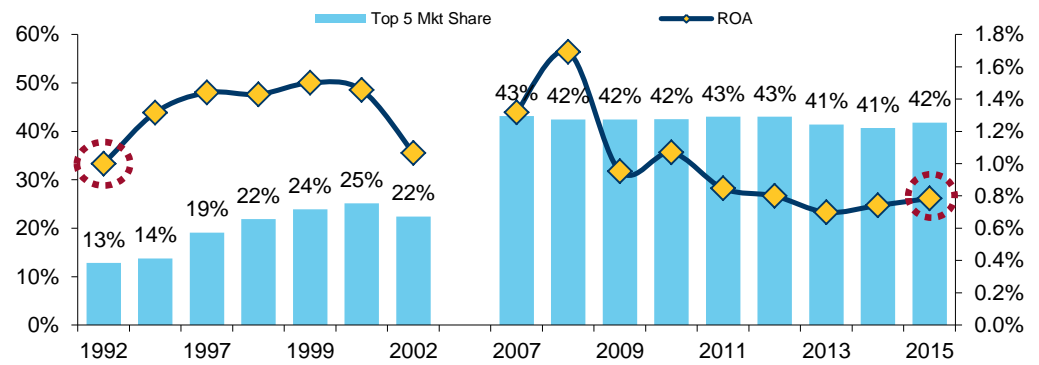

Source: Company data, Institutional Investor, Credit Suisse Research

The trust banks today are investing and exploring various use cases for blockchain, and, while we think it is too early to reach any definite conclusions here, we favor franchises less reliant on custody, the business most vulnerable to disruptive change. To this end, BNY Mellon and Northern Trust screen better than State Street given more diverse business models. One derivative of blockchain becoming more widespread is lower counterparty risk, which should alleviate some capital requirements and benefit the custodians.

**Figure 89: STT's Greater Custody Revenue Exposure Open to Blockchain Disruption**

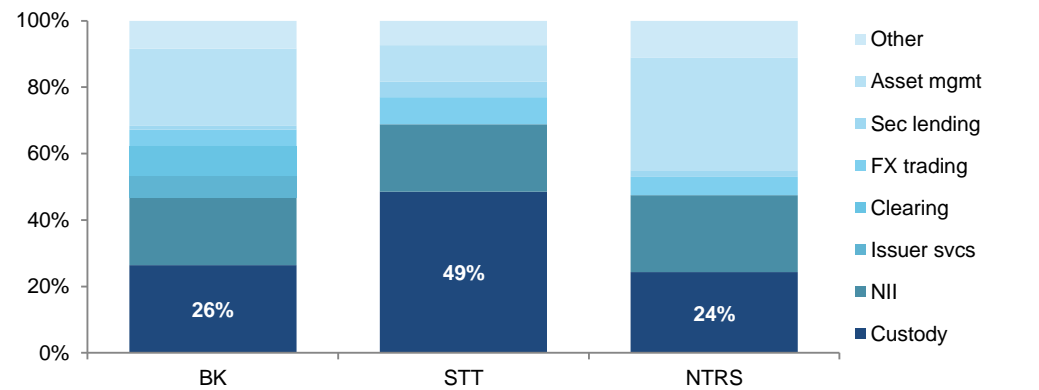

Source: Company data, Credit Suisse Research

# Financial Services

## Use case

### Research Analysts

**Hugo Swann**

44 20 7883 2574

hugo.swann@credit-suisse.com

**David Da Wei Wong**

44 20 7883 7515

daviddawei.wong@credit-suisse.com

### Ledger Duplication

Currently financial institutions each maintain their own asset registers, and often these registers are product and/or region specific; the larger banks may have hundreds of ledgers (IBT, 11<sup>th</sup> November 2015), including those acquired from other firms, and registers housed on legacy platforms. Not only are these ledgers numerous, but their reconciliation is costly (Banking & Securities IT spend relative to GDP generated is the second highest vs other sectors), complex and often requires manual alterations.

In many large investment banks, for example, back and middle offices software solutions often rely upon coding languages as unwieldy and primitive as VBA to reconcile and maintain databases that account for transactions. This results in human error, inefficiencies and therefore a decreased ability to manage risk.

Creating single, or perhaps multiple, databases between major banks resting upon a blockchain, it is argued, could reduce these frictions. Richard Brown, of the R3 banks consortia, explains: "Through one global logical ledger, financial firms will move from systems-of-record at the level of the firm to an authoritative systems-of-record at the level of a market. These records would sit logically outside each firm on a shared ledger, accessible only to anybody (or anything, such as an authorized smart contract) with an interest in the assets and agreements they manage." (IB Times, 11<sup>th</sup> Nov 2015)

**Figure 90: Percentage of sector GDP spent on IT**

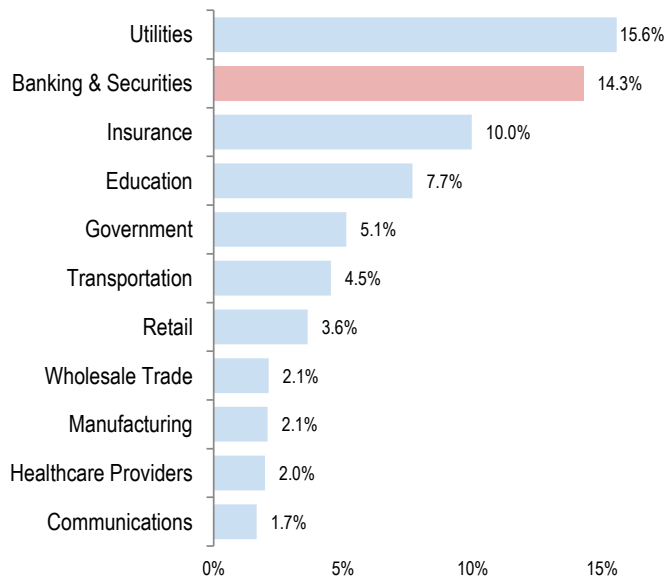

Source: Gartner, US BEA, Credit Suisse research

**Figure 91: Blockchain's impact to the ecosystem**

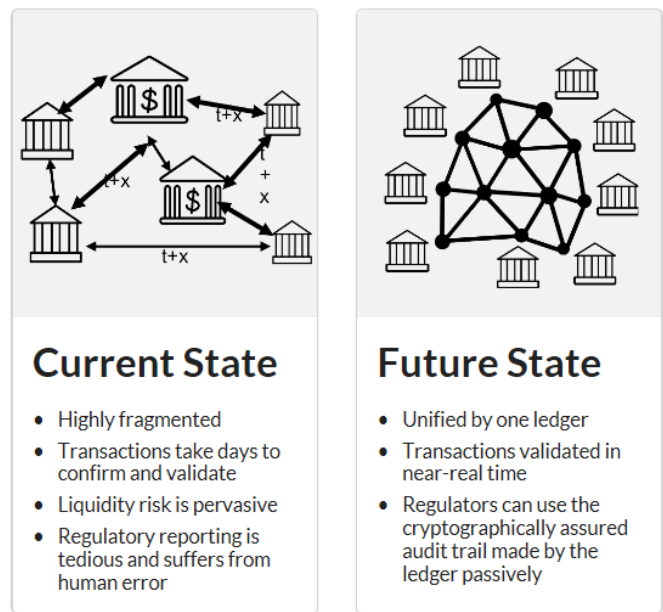

Source: R3CEV, Credit Suisse research

Consider the below example (Figure 92) from Consult Hyperion that shows the significant duplication in a siloed ledger system. Bank A records that Bank C owes them £5m and Bank C also records what they owe Bank A. This duplication means that each ledger line is recorded twice in separate, individually expensive systems, reconciliation between which takes time and even more expense.

It is also interesting that customers are at the behest of banks' records. Although we take this for granted, Consult Hyperion note how conceptually odd it is that 'Customer A has to trust that the bank will be good for the money and that the bank's records will be accurate.'

**Figure 92: Visualizing centralized ledgers for three banks and their customers**

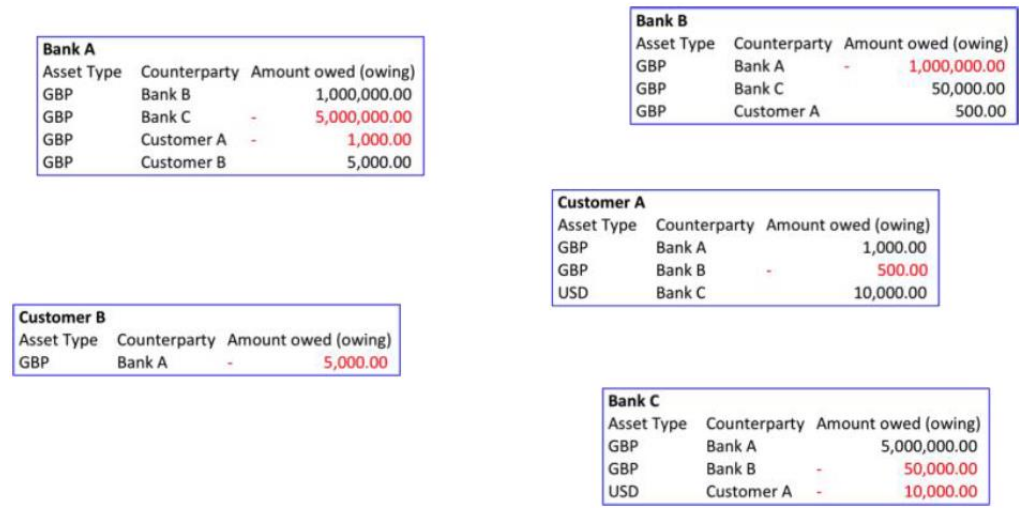

Source: Towards Ambient Accountability in Financial Services by Birch, Brown and Parulava, Credit Suisse research

In sum, we have both a problem of trust, and a problem of centralized duplication. Implementing a permissioned private ledger like that proposed by R3CEV would leave participating banks in the position of consensus maintenance, and mean that the ledger contents remained invisible to those without permission to view it.

**Figure 93: A permissioned private ledger with control and contract functionality is likely the most relevant for Financial Services**

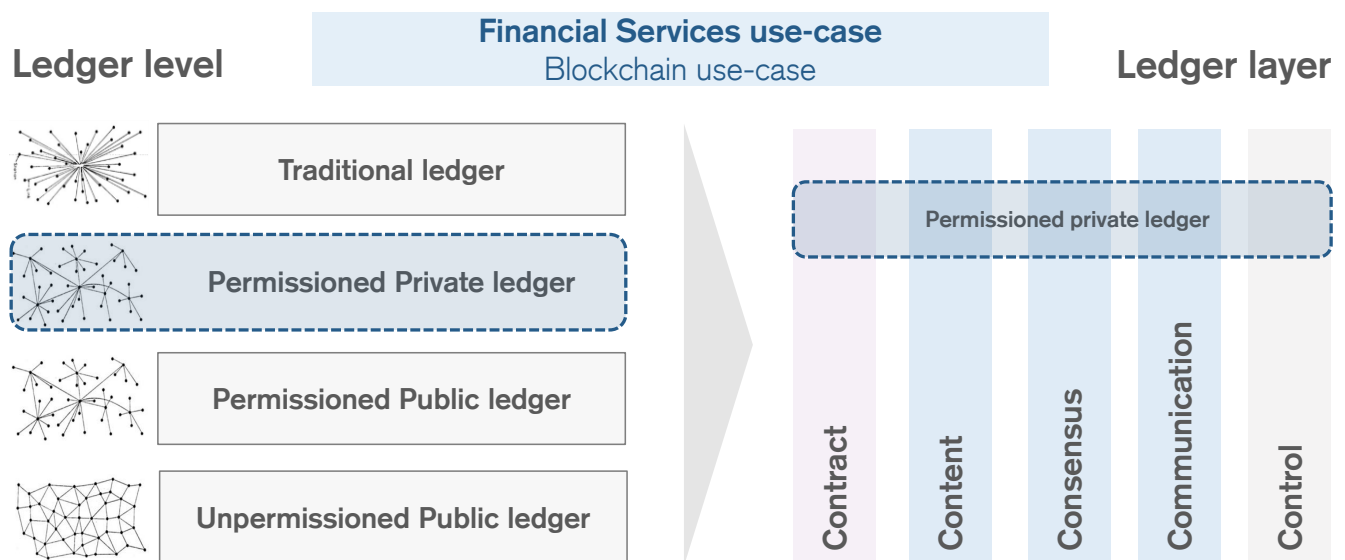

Source: Credit Suisse research based on data from Consult Hyperion and On Distributed Communications Networks by Paul Baran, 1962

This would result in a rationalization of the ledgers we looked at before. As the below shows, through distribution we remove duplication, creating a greatly streamlined equivalent solution with enhanced security and functionality without sacrificing detail.

**Figure 94: Combining the ledgers on a distributed permissioned private ledger**

Bank A		
Asset Type	Counterparty	Amount owed (owing)
GBP	Bank B	1,000,000.00
GBP	Bank C	- 5,000,000.00
GBP	Customer A	- 1,000.00
GBP	Customer B	5,000.00

Bank B		
Asset Type	Counterparty	Amount owed (owing)
GBP	Bank A	- 1,000,000.00
GBP	Bank C	50,000.00
GBP	Customer A	500.00

Bank C		
Asset Type	Counterparty	Amount owed (owing)
GBP	Bank A	5,000,000.00
GBP	Bank B	- 50,000.00
USD	Customer A	- 10,000.00

Customer A		
Asset Type	Counterparty	Amount owed (owing)
GBP	Bank A	1,000.00
GBP	Bank B	- 500.00
USD	Bank C	10,000.00

Customer B		
Asset Type	Counterparty	Amount owed (owing)
GBP	Bank A	- 5,000.00

Issuer	Holder	Asset	Amount
Bank A	Bank C	GBP	5,000,000.00
Bank A	Customer A	GBP	1,000.00
Bank B	Bank A	GBP	1,000,000.00
Bank C	Bank B	GBP	50,000.00
Bank C	Customer A	USD	10,000.00
Customer A	Bank B	GBP	500.00
Customer B	Bank A	GBP	5,000.00

Source: Towards Ambient Accountability in Financial Services by Birch, Brown and Parulava, Credit Suisse estimates

Benefits of this approach could include:

■ **Cost removal – Back office**

Obviation of the need for legacy systems, elimination of duplication, and reductions in post-trade settlement and reconciliation complexity could take out costs. Santander, Oliver Wyman and Anthemis (July 2015, [click for report](#)) suggest that within seven years banks' cost base could be reduced by an aggregate 15-20bn USD within seven years.

Beyond these costs, smart contracts run on top of the blockchain have the potential to automate existing logic in contracts which have multiple payment strands. Increasingly the majority of financial assets exist only in electronic form; therefore it is conceivable that from CDOs to derivatives and repo agreements, a great many products could be governed by smart contracts intrinsic to tokens on the chain. This could reduce remittance and initiation costs – RC3EV note, for example, that new OTC derivative products can cost over 20m USD and require weeks of (often highly paid) work.

■ **Risk management – Middle office**

Increased speed of settlement potentially increases liquidity, decreasing balance sheet risk, and presenting savings in middle office risk management. Axel Weber, former chairman of UBS and Bundesbank President sees blockchain as a 'huge opportunity' for the banking industry: "If you can settle in two hours instead of two days, you can turn over your balance sheet in the same activity 24 times. Just imagine the profitability that this will bring to financial institutions that are payment focused and transaction focused" (IIF CEO panel discussion, October 9<sup>th</sup> 2015).

■ **Regulatory wins – Legal and Compliance**

Compliance with regulation is costly. A regulator permissioned to view a transparent ledger shared by the financial services industry could potentially drastically reduce the cost of Anti Money Laundering - AML, Know Your Client - KYC and Countering the Financing of Terrorism - CFT regulations. The regulator could individually trace the provenance of assets, and if identity were successfully stored on the private chain, the regulator could interrogate the single 'source of truth' at its convenience.

**Figure 95: A multiplicity of potential use-cases span the breadth of financial services**



Source: R3CEV, Credit Suisse research



# Analyst View

## Financial Services

### Research Analysts

**Hugo Swann**  
44 20 7883 2574  
hugo.swann@credit-suisse.com

**David Da Wei Wong**  
44 20 7883 7515  
daviddawei.wong@credit-suisse.com

### Market opportunity

- **Cost cutting** – A shared ledger system creates significant opportunity for cost cutting in a number of areas where current processes are slow, cumbersome and highly frictional. These areas include the processing of trades in securities, trade finance and also in payments, particularly cross-border payments/transactions (which we discuss in detail later). These have been well flagged in the press, however, there remains limited consensus as regards the magnitude and timing of these savings, or even whether the savings will accrue to the banks, or be competed away by new entrants. Santander have estimated the savings in securities trading and international payments as US\$15-20bn pa ([click for report](#)) by 2022.
- **Revenue** – In addition, there are opportunities on the revenue side. Shared ledger systems combined with better data analytics may enable a heightened understanding of clients. This could lead to more products being sold to existing clients (where current client needs are not currently identified). It may lead to more clients being identified, particularly where a shared ledger allows for faster payment times, and big data/internet of things allows for better monitoring of collateral or other risk mitigants. For example, SME trade finance may grow significantly if banks' understanding and monitoring of the goods and counterparties they are financing becomes cheaper, easier, faster and more accurate.

These cost savings and revenue opportunities come at a time when bank profitability is under pressure from low rates, increasing regulatory costs and capital requirements. Assessing the impact of these changes depends upon the implementation path taken. At the moment there are a number of consortia exploring the possibilities, yet there is little clarity as to the likely impact.

One thing that is clear is that the current combination of low profitability and the potential threat of competition from new entrants is forcing the banks to reassess their processes and IT structures in a fundamental way. This means the future banking landscape and both the size and allocation of profits from banking may change substantially. However, it is also possible that the incumbents are able to defend their current positions via a combination of regulatory protection and proactive adaptation to (and of) new systems.

### Who wins and who loses?

A change in technology can open up an opportunity for new entrants into a marketplace. However, we think there are a number of reasons why it's likely that incumbent banks are the most likely winners, rather than new entrants, though which incumbents remains very unclear. We note:

- **Many banking activities are highly regulated** – we think regulators would rather keep many banking activities inside the existing regulated environment of the banking system. The alternative of allowing some banking services to move into a less understood, less proven and less regulated "FinTech" system is likely to happen only slowly, in our view. Clearly, there are non-banking entities already working closely with the existing banking systems (eg payment processing companies), but these are also well established structures that have evolved over a number of years.
- **Client relationships are important** – banks already have a wealth of data on their clients. While these data are often not fully utilised by the banks, we think that it

presents an opportunity which the banks are focused on leveraging more successfully. We think these data will be difficult for new entrants to build and so allows the banks a level of privileged insight into client needs and behaviors.

- **Banks have the trust of their clients** – whilst a shared ledger may reduce the need for trust between entities recording transactions in the ledger, we think trust between the end client and the bank is still likely to be important. These relationships make it more difficult for new entrants to replace banks, though they may work alongside.
- **Bank focus on this is mixed** – some of the major banks are spending a lot of time working with specialists in this field, while some appear to have done relatively little. This may give an edge to the focused banks. However, given the benefits of establishing a common practice between a large number of contributors to the shared ledger, it may be that some banks are able to 'free ride' on the work of others, particularly if those banks are able to bring a large number of clients/transactions to the ledger. This would work against the new entrant into the market place.

In our view, a big problem with many of the benefits of blockchain is that they accrue directly to the cost base of the banks. These cost savings may not translate into better profitability, and we wonder if homogenous industry wide cost savings may simply be passed on to customers as they are competed away.

#### **How likely is this to happen?**

Given the number of banks looking at the opportunity and threats from shared ledger and the pressures facing profitability, we think some adoption of this technology is likely. This is not least because a number of exchanges and clearing houses appear to be keen to implement some form of shared ledger which will force banks transacting through these exchanges to become part of the network.

In addition, for some of the global banks, simply implementing a shared ledger for international payments within their own operation could result in faster, cheaper, safer payments for customers.

However, we think the implementation of this is likely to take quite some time. A key hurdle to this the view of regulators and legal requirements around data protection for clients. It appears to us that for some applications, the larger the shared ledger the more powerful it would become. However, this would be likely involve approval of the structures across many jurisdictions and so more regulators and more scrutiny under different legal frameworks, adding complexity and time.

Moving from legacy systems is tough—many global banks are running IT systems that are complex and aging. This adds to the attraction of a change in IT structure to the incumbent banks. However, moving existing data on clients and their transactions across onto a shared ledger is likely to involve a lot of cost and creates risks around laying down inaccurate data into an immutable ledger. This may present a significant barrier/delay for the use of this system.

## **Focusing on implications for transaction banking**

At this stage, we think that the blockchain's immutability and 'tamper-proof' properties, as well as the ability for all relevant parties to view the transaction record without undertaking laborious reconciliation, could be relevant for certain payment/transaction related businesses.

The following section looks at one possible application, in transaction banking. As we discuss then, there is no clear-cut evidence pointing to obvious winners and losers over the long-term.

For example:

- At one extreme, banks' roles (and revenues) in global payments and trade is significantly reduced, perhaps to the level of just providing financing, while distributed ledgers owned by, say, technology companies handle the payments, validate ownership etc<sup>15</sup>.
- A more plausible alternative, we think, is that the banks establish their own blockchain platform, with the help of FinTech companies – we note the collaboration already taking place here. This could then point to competition between groups of banks, such as smaller regional lenders aiming to use blockchain to disrupt the businesses of global transaction banks (e.g. DB, HSBC and Standard Chartered).

**Incumbent banks make significant revenues from facilitating global payments and trade**

There are two main kinds of business we discuss here, based on data from the BCG's Global Payments 2015 report:

- **Payments and cash management services (c\$243bn global revenue)** – banks help corporates with, e.g. managing cash flow and making cross-border payments. Revenues come from net interest income and fees on current accounts, fees on making cross-border transactions, FX conversion services etc.
- **Trade finance (c\$45bn global revenues)** – essentially the banks ensure that importers receive goods they have paid for, and exporters receive payment for their goods. They provide finance by extending letters of credit, and check this against various pieces of documentary evidence (e.g. bills of lading stating the goods have been shipped). The process is fairly labour-intensive and paper-based, and can be subject to fraud.

Among the European banks, there are several which have large payment-related businesses (Figure 96).

**Figure 96: Several European banks have meaningful transaction banking businesses**

Transaction banking as % of Group revenues

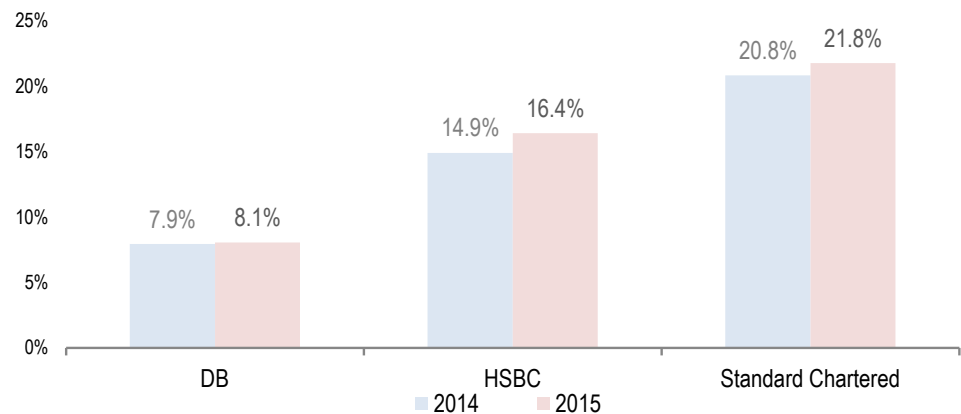

DB – "Trade Finance and Cash Management" within Global Transaction Banking. HSBC – Sum of Payments & Cash Mgmt and Global Trade and Receivables Finance. Standard Chartered – Sum of Trade and Cash Mgmt and Custody  
 Source: Company data, Credit Suisse research.

<sup>15</sup> For further details, see the BCG's working paper "Embracing Digital in Trade Finance".

**The blockchain could target areas like correspondent banking...**

The current cross-border payments system is actually quite complex. When, for example, an importer pays an exporter in another country, the transaction is often intermediated by a correspondent bank (Figure 97). This happens because the Banks A and B (which could be domestic lenders) have no direct relationship with each other. The correspondent bank derives revenues from, e.g. fees in maintaining the correspondent accounts, and foreign exchange services.

**Figure 97: How a correspondent bank intermediates between cross-border payments**

Arrows denote the flow of payments

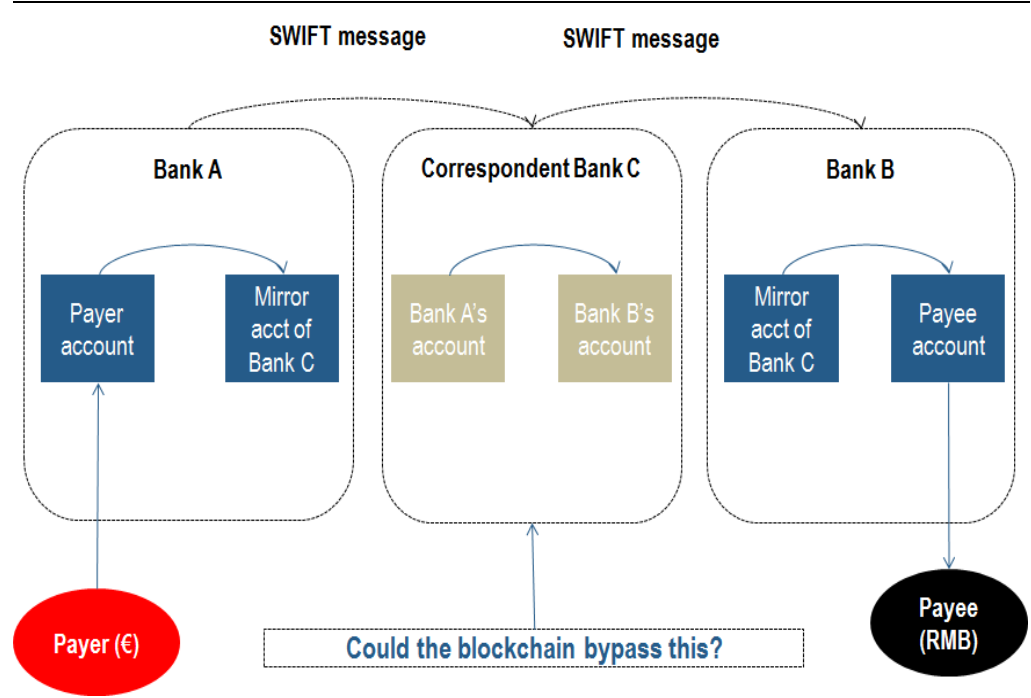

Source: Bain & Company "Distributed Ledgers in Payments: Beyond the Bitcoin Hype", Credit Suisse research.

A McKinsey-SIFMA study<sup>16</sup> suggests that using blockchain for cross-border B2B (business-to-business) payments could generate c\$50-60bn of "value" resulting from lower costs/fees and better security and speed. This would accrue more to customers than the banks, if a blockchain platform were to enable direct transactions between the counterparties (Banks A and B) without a correspondent bank.

One example of a platform is Ripple, a privately owned company founded in 2012. It explicitly offers "an alternative to correspondent banking", by allowing direct bank-to-bank settlement of cross-currency payments. Ripple offers "Ripple Network" which contains a secure distributed ledger (Ripple Consensus Ledger, RCL) which holds the order book, together with various interfaces to allow banks to connect to the RCL.

<sup>16</sup> SIFMA Blockchain Roundtable: Survey Discussion (May 2016)

### ...but also an opportunity to improve business models

We stress that this is not a one-sided assault by "disrupters" on the incumbents. The banks are also experimenting with the technology. For example:

- DBS (The Development Bank of Singapore) and Standard Chartered have tested a distributed ledger for trade finance in late 2015. This exploits the blockchain's immutability to minimise the risk of fraudulent invoices or "double financing". Further, the distributed ledger allows third parties such as customs officials to check transactions directly, and digitisation removes the need for paper-based verification. Over time, this could benefit global trade flows as processes become more secure and efficient<sup>17</sup>.
- Santander UK is testing an internal blockchain among its staff to make international payments between £10 and £10,000 (with conversion to EUR and USD possible). Interestingly, Santander is using Ripple's technology<sup>18</sup> — this shows that the competition is not necessarily between "startups" and banks, we think. It could well be between different groups of banks, e.g. regional vs international lenders.

### The main questions – scalability and broad participation, regulation and timescale

- Perhaps unsurprisingly, a global blockchain platform for transactions would require participation not just from the banks, but from other players such as distributors, customs etc. However, there does not seem to be a large transaction-banking consortium so far, whereas the likes of PTDL<sup>19</sup> and R3CEV within capital markets have between 40-50 participants (from banks and non-banks).
- Regulators would have to approve the technology, we think. They have, in the past, penalised banks heavily<sup>20</sup> for breaches of anti-money laundering/sanctions-related rules and would need reassurance that the new technology genuinely minimises the risk of fraudulent transactions. The technology companies have faced issues of their own here – for example Ripple was fined \$700,000 by US regulators for violating several requirements of the Bank Secrecy Act<sup>21</sup>.
- Lastly, we should stress that the technology appears to be a medium-term (3-5 years out) prospect, at earliest. For example in trade finance, the BCG noted the "general consensus amongst banks and non-banks" was that mainstream applications were "at 5+ years away".

---

<sup>17</sup> "How blockchains might boost global trade" by Michael Vrontamitis, Global Head, Trade Products, Transaction Banking, Standard Chartered Bank

<sup>18</sup> For more details, see <https://ripple.com/insights/santander-becomes-first-uk-bank-use-ripple-cross-border-payments/>

<sup>19</sup> Post Trade Distributed Ledger Group

<sup>20</sup> For example, HSBC and Standard Chartered in 2012, and BNP in 2014.

<sup>21</sup> Please see [https://www.fincen.gov/news\\_room/nr/html/20150505.html](https://www.fincen.gov/news_room/nr/html/20150505.html). The alleged violations included "failing to implement and maintain an adequate anti-money laundering program".

# Goldman Sachs Group, Inc. (GS)

Rating	<b>OUTPERFORM</b>
Price (29-Jul-16, US\$)	158.92
Target price (US\$)	180.00
52-week price range	205.97 - 139.51
Market cap (US\$ m)	66,014.42
Enterprise value (US\$ m)	66,014.42

\*Stock ratings are relative to the coverage universe in each analyst's or each team's respective sector.

†Target price is for 12 months.

## Among best-positioned to reap blockchain benefits

After meeting Marty Chavez, Goldman's Chief Information Officer, in Dec. 2015 we walked away clear that as regards technology, Goldman will (1) embrace disruption, (2) seek to spend offensively, and (3) pursue the best available talent. We see this strategy evidenced in their approach to blockchain.

### Research Analysts

<b>Christian Bolu</b> 212 538 9805 christian.bolu@credit-suisse.com
<b>Susan Roth Katzke</b> 212 325 1237 susan.katzke@credit-suisse.com
<b>Richard Fellinger</b> 212 325 7909 richard.fellinger@credit-suisse.com
<b>Athena Xie</b> 212 538 3253 athena.xie@credit-suisse.com

- **Blockchain, not bitcoin...** Despite originally investing in bitcoin (filed patent application entitled 'Cryptographic Currency for Securities Settlement' in Oct'14 and led bitcoin payment app Circle's \$50m funding round in Apr'15) Chavez confirmed Goldman is not interested in bitcoin. Management is, however, interested in blockchain. This is seen as one of the most interesting developments on the tech front – equal in import to Cloud and Open Source. Although expected to take years, likely to be incredibly disruptive, massively changing the structure of markets, Goldman is putting its best people on this.

- **Goldman's technology organization and budget...** engineers account for 30% of firm-wide employees with a total tech budget that we estimate at \$2.5-3.2bn annually, inclusive of maintenance costs (roughly one-third of the total, and declining) – the remaining 70% is strategically oriented (compare with 50% at JPM). The goal is to reduce legacy spend to 10%, potentially freeing \$0.6-0.8bn to be invested strategically or dropped to the bottom line.

- **Blockchain amongst key strategic priorities:** Invest in and leverage opportunities around automation, data analytics/big data and blockchain technology to move up the value chain with clients and reduce legacy spend.

- **Our thesis on GS...** We think direct investments in technology should be quite valuable, to both Goldman's product/knowledge base and its earnings/book value (at monetization). Goldman is a best-in-class capital markets franchise with competitive positioning across myriad businesses. GS invests heavily to sustain that positioning; operating leverage and market share consolidation should drive above-average growth and returns, supporting share price outperformance.

### Share price performance



On 29-Jul-2016 the S&P 500 INDEX closed at 2171.96  
Daily Jul30, 2015 - Jul29, 2016, 07/30/15 = US\$207.2

Quarterly EPS	Q1	Q2	Q3	Q4
2015A	5.94	1.98	2.90	1.27
2016E	2.68	3.72	3.21	5.06
2017E	-	-	-	-

### Financial and valuation metrics

Year	12/15A	12/16E	12/17E	12/18E
EPS (CS adj.) (US\$)	12.14	14.62	16.95	19.35
Prev. EPS (US\$)	-	-	-	-
P/E (x)	13.1	10.9	9.4	8.2
Relative P/E (%)	71	59	58	57
Revenue (US\$ m)	33,820.0	29,250.5	31,282.3	33,266.4
Preprovision Income (US\$ m)	8,778	9,599	11,107	12,206
Book Value (US\$)	171.03	186.01	200.24	217.95
Tangible book value (US\$)	161.64	176.11	190.24	207.72
ROE (%)	7.4	8.3	9.0	9.5
ROA (%)	0.65	0.71	0.79	0.85
Book Value (Next Qtr., US\$)	182.4	Tangible BV (Next Qtr) (US\$)		172.54
P/BV (x) (Next Qtr.)	0.90	P/TBV (Next Qtr) (x)		0.9
Dividend (current, US\$)	2.8	Shares Outstanding (m)		415
Dividend yield (%)	1.6			

Source: Company data, Thomson Reuters, Credit Suisse estimates

## JPMorgan Chase & Co. (JPM)

Rating	<b>OUTPERFORM</b>
Price (29-Jul-16, US\$)	63.97
Target price (US\$)	75.00
52-week price range	68.89 - 53.07
Market cap (US\$ m)	234,246.41
Enterprise value (US\$ m)	234,246.41

\*Stock ratings are relative to the coverage universe in each analyst's or each team's respective sector.

†Target price is for 12 months.

### Research Analysts

#### Susan Roth Katzke

212 325 1237

susan.katzke@credit-suisse.com

#### Athena Xie

212 538 3253

athena.xie@credit-suisse.com

## Strategic blockchain investments yield results

- DLT is a strategic priority:** JPM consider blockchain and DLT to represent the most nascent 'select area of innovation.' The bank is investing both directly and in third parties, with such investment representative of a broader determination to equip themselves to not just face, but lead the disruptive FinTech evolution/threat. CEO Jamie Dimon has been quite clear that "Silicon Valley is coming"; he is also quite clear that JPMorgan will position itself to stay one step ahead. Technology remains a key strategic investment priority, with the strategic tech budget increasing (north of \$9bn); c.40k technology employees comprise 17% of group headcount.
- Innovation yields results:** The Wall Street Journal reports (22<sup>nd</sup> Feb 2016) JPM have built Juno - a 'distributed cryptolledger'. An innovative consensus layer enables scalability far greater than PoW systems, un-optimized Juno achieved 500 transactions per second on a macbook pro, and the team believes that optimized it could rival Visa. Juno is operational, having already transferred USD from London to Tokyo for about 2,200 clients.
- Disruptive intentions, not without setbacks:** According to Corporate and Investment Banking Head Daniel Pinto, the intention is to explore how this tech can be repurposed to streamline currency, clearing and settlement-reducing latency time and risk (consider the opportunities-reduced funding costs; reduced operating risk/losses/costs)—in addition to a more efficient record of securities ownership. Disruptive intentions may be set back by the mid-June departure of lead developer Will Martino and leader Stuart Popejoy; it's clearly a challenge to retain top talent; JPMorgan, like Goldman Sachs remain among the best positioned to attract and retain talent, given the senior level/CEO commitment and capacity to invest in the FinTech arena.
- Our thesis on JPM:** JPM's increasing tech budget, close links with successful blockchain start-ups and early success in scaling the capacity of its distributed ledger bolsters our positive view – reiterate Outperform.

### Share price performance



On 29-Jul-2016 the S&P 500 INDEX closed at 2173.6

Daily Aug03, 2015 - Jul29, 2016, 08/03/15 = US\$68.53

Quarterly EPS	Q1	Q2	Q3	Q4
2015A	1.45	1.54	1.32	1.32
2016E	1.35	1.52	1.34	1.41
2017E	1.47	1.53	1.53	1.57

### Financial and valuation metrics

Year	12/15A	12/16E	12/17E	12/18E
Operating EPS	5.64	5.62	6.10	6.85
Prev. Operating EPS	-	-	-	-
EPS (CS adj.) (US\$)	6.00	5.65	6.10	6.85
Prev. EPS (US\$)	-	-	-	-
P/E (x)	10.7	11.3	10.5	9.3
Relative P/E (%)	58	61	64	64
Revenue (US\$ m)	96,633.0	97,046.6	100,731.2	106,696.0
Preprovision Income (US\$ m)	37,619	42,127	43,574	47,270
Book Value (US\$)	60.46	64.33	67.67	71.39
Tangible book value (US\$)	48.13	51.64	54.59	57.90
ROE (%)	10.6	9.3	9.6	10.2
ROA (%)	0.99	0.93	0.95	0.98
Book Value (Next Qtr., US\$)	63.4	Tangible BV (Next Qtr) (US\$)		50.82
P/BV (x) (Next Qtr.)	1.02	P/TBV (Next Qtr) (x)		1.3
Dividend (current, US\$)	1.9	Shares Outstanding (m)		3,662
Dividend yield (%)	2.6			

Source: Company data, Thomson Reuters, Credit Suisse estimates



## Experian (EXPN.L)

Rating	<b>OUTPERFORM</b>
Price (29 Jul 16, p)	1477.00
Target price (p)	1505.00
Market Cap (£ m)	14,146.4
Enterprise value (£ m)	16,365.9

\*Stock ratings are relative to the coverage universe in each analyst's or each team's respective sector.  
†Target price is for 12 months.

### Research Analysts

#### Andy Grobler, CFA

44 20 7883 5943  
andy.grobler@credit-suisse.com

#### Karl Green

44 20 7888 2629  
karl.green@credit-suisse.com

#### Daniel Hobden

44 20 7883 3290  
daniel.hobden@credit-suisse.com

## Blockchain – only a distant and partial concern

- Credit Bureau:** Credit bureaus play a key role in the current functioning of consumer credit-based economies. The collection, analysis and distribution of data across multiple vertical markets enables the risk adjusted flow of credit through the economy. At the core of these businesses are vast databases containing the credit history of hundreds of millions of consumers in its key end markets. For Experian these key markets are the UK, US and Brazil but it has consumer bureaus in 19 countries.
- Risks:** The longer term risk for the bureau is that financial institutions build a shared ledger of consumer activity on a common system that allows institutions to build, maintain and access a full spectrum of data on any individual. This potentially diminishes the value of the credit bureau data.
- Only part of the value proposition:** Credit bureaus offer more than the collection and redistribution of data from financial services. Data series are significantly broader, historical data has tangible value, the analysis and the implementation of analytical systems are important and, potentially most critically, Experian is an objective third party custodian of data. This has value to both consumers (its objectivity) and potentially the consortium data provided to a bureau is not accessible to competitors – in a blockchain register, all information is accessible.
- Our view:** While the development of blockchain could potentially be disruptive, both the time scale of creating a unified register with sufficient history to offer a viable alternative to elements of a bureau offering plus the value of having regulated third party entities at the heart of the credit economy suggest to us that the existing approach will be maintained. We will monitor any changes but for now we think that even if blockchain does offer a partial alternative over time it will be at least 10 years (5 years to create and 5 years to build usable history) before any potential commercial impact could be felt. Given the time frame and the breadth of Experian's offering, we retain our Outperform rating.

### Share price performance

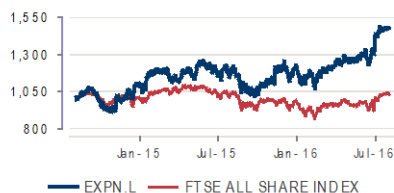

The price relative chart measures performance against the FTSE ALL SHARE INDEX which closed at 3653.8 on 29/07/16. On 29/07/16 the spot exchange rate was £.84/Eu 1.- Eu.9/US\$1

Performance	1M	3M	12M
Absolute (%)	3.0	16.7	22.8
Relative (%)	1.2	9.0	23.6

### Financial and valuation metrics

Year	3/16A	3/17E	3/18E	3/19E
Revenue (US\$ m)	4,477.0	4,757.2	5,003.3	5,257.2
EBITDA (US\$ m)	1,545.7	1,666.4	1,767.3	1,866.9
Pre-tax profit adjusted (US\$ m)	1,118.67	1,187.61	1,273.93	1,376.30
CS EPS (adj.) (US\$)	0.87	0.95	1.01	1.09
Prev. EPS (US\$)	-	-	-	-
ROIC (%)	15.0	15.7	17.3	19.0
P/E (adj.) (x)	22.4	20.6	19.4	17.9
P/E rel. (%)	136.1	119.1	129.4	135.6
EV/EBITDA (x)	14.1	13.1	12.1	11.1
Dividend (03/17E, US\$)	0.43	Net debt/equity (03/17E,%)		129.5
Dividend yield (03/17E, %)	2.2	Net debt (03/17E, US\$ m)		3,192.8
BV/share (03/17E, US\$)	2.6	IC (03/17E, US\$ m)		5,658.4
Free float (%)	100.0	EV/IC (03/17E, (x))		3.9

Source: Company data, Thomson Reuters, Credit Suisse estimates

# Santander (SAN.MC)

Rating	<b>NEUTRAL</b>
Price (29 Jul 16, €)	3.79
Target price (€)	3.80
Market Cap (€ m)	54,764.5

\*Stock ratings are relative to the coverage universe in each analyst's or each team's respective sector.

†Target price is for 12 months.

## Blockchain – current investments for distant benefits

### Research Analysts

**Andrea Unzueta**  
44 20 7888 2692  
andrea.unzueta@credit-suisse.com

- Investing in blockchain:** Santander is amongst the financial institutions investing in blockchain technology. Through its subsidiary, Santander UK, it became the first UK entity to introduce a blockchain architecture enabling international payments, and like many of its European peers, it continues to focus on investments for what is referred to as the sector's 'digitalization era'. The aim is to simplify banking processes and significantly reduce costs.
- Unclear how a blockchain world will look:** It is still very early innings for the financial industry and it is not obvious a decentralized system will become the norm in the future. Risks are related to customer trust, legal and regulatory concerns.
- Players with scale should benefit:** International larger players, such as SAN, are likely to be the main beneficiaries of such technologies, especially if blockchain technology is extended beyond the payment system. As such, these entities are naturally currently more involved. This could represent an edge initially in the process.
- Not yet a concern for investors:** We believe the implementation is likely to take some time and although relevant, blockchain (or FinTech in general) is not (yet) a subject investors are focusing on. Santander's franchise, earnings power and ability to be ahead of peers when it comes to innovation strategies are not in question, in our view.
- Maintain Neutral:** For us, it is the regulatory environment that makes an investment decision on the stock difficult, with the bank's CET1 ratios standing amongst the lowest of the sector at a time when profitability levels (and thus capital generation) are also under pressure (due to lower revenues in Spain, higher provisions in Brazil, and uncertainty in the UK). We maintain our Neutral rating.

### Share price performance



The price relative chart measures performance against the MADRID SE INDEX which closed at 864.0 on 29/07/16. On 29/07/16 the spot exchange rate was €1/Eu 1.- Eu.9/US\$1

Performance	1M	3M	12M
Absolute (%)	9.1	-14.2	-39.1
Relative (%)	3.1	-9.0	-15.3

### Financial and valuation metrics

Year	12/15A	12/16E	12/17E	12/18E
Net income reported (€ m)	5,966	5,672	6,695	7,467
Adjusted net profit (€ m)	6,566	5,631	6,414	7,098
EPS stated (€)	0.44	0.39	0.45	0.50
CS adj. EPS (€)	0.49	0.39	0.43	0.48
Prev. EPS (€)	-	-	-	-
Tangible book value (€ m)	58,610	62,168	65,711	69,664
ROTE avg (adj.) (%)	12.0	9.3	10.0	10.5
P/E (adj.) (x)	7.81	9.83	8.76	7.96
Price/Tangible BPS (x)	0.93	0.90	0.86	0.81
Dividend (12/16E, EUR)	0.19	B3 Transitional RWAs (12/16E, €)		0
Dividend yield (12/16E, %)	5.1	Basel 3 FL CET1 ratio (12/16E, %)		10.8
Free float (%)	98.8	Number of shares (m)		14,434.5

Source: Company data, Thomson Reuters, Credit Suisse estimates

# Media

## Use case

### Global Media Team

**Omar Sheikh**  
212 325 6818  
omar.sheikh@credit-suisse.com

**Sophie Bell**  
44 20 7883 1488  
sophie.bell@credit-suisse.com

**Joseph Barnet-Lamb**  
44 20 7883 3535  
joseph.barnet-lamb@credit-suisse.com

**Lawrence Dann-Fenwick**  
212 538 8442  
lawrence.dann-fenwick@credit-suisse.com

### A Content blockchain

*'In the race to adopt new technologies, the music industry historically has finished just ahead of the Amish.'*

– American record label executive Stan Cornyn

Some believe a music industry built on blockchain rails has the potential to drastically reduce piracy, and may be a force of disintermediation for distributors and streaming solutions, putting greater content control in the hands of the artist.

In 2015 Imogen Heap made history by being the first artist to release a song – 'Tiny Human' – exclusively on a blockchain-based platform – Ujo Music, which is run on Ethereum. She, along with other artists, start-ups and companies (Bittunes and PeerTracks) envisage a world in which all content and its metadata (information identifying those with legitimate revenue claims: creators, owner or beneficiaries) is transparently, accurately and immutably stored – on a blockchain.

Music has multiple rights owners – from the writers, to labels, licenses and the artists themselves. Given the single 'source of truth' proposed above, smart contracts could be embedded in content, creating autonomous rules that would ensure, for example, that once purchased, revenue is correctly distributed to the designated parties. This potentially enables more direct interaction between artist and audience and smart contracts.

**Figure 98: A permissioned ledger which is visible to all and in possession of smart-contract functionality appears to offer the most promise in the media space**

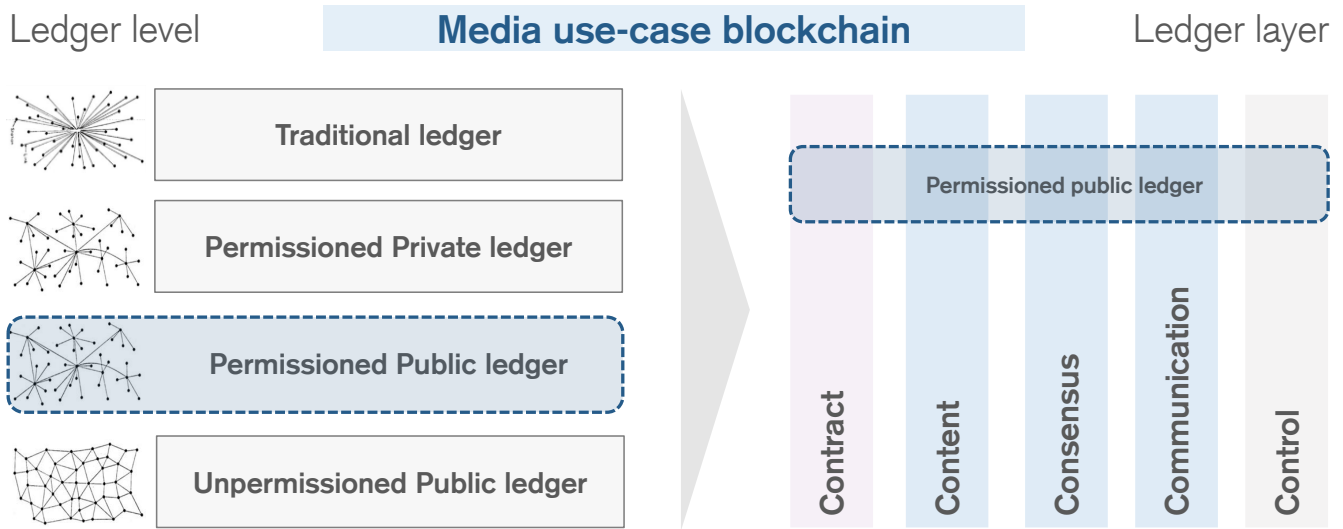

Source: Credit Suisse research based on data from Consult Hyperion and On Distributed Communications Networks by Paul Baran, 1962

The benefits are potentially manifold:

- **Attribution:** Current content databases lack 'hygiene' and are highly fragmented. Attribution of content to its rightful creators and rights holders could be more easily achieved through a blockchain given its properties of transparency and immutability. It would be easy to confirm authenticity/integrity of content, a hash of the contents data could be saved on the blockchain, a simple comparison of your copy of the file with the hash on the shared ledger would confirm (or dismiss) its authenticity.
- **Royalty payments:** Under a blockchain system, those with a legitimate claim to content are remunerated for content usage under terms they define; execution is performed autonomously by smart contracts. Heap speaks to the import of this saying "the single biggest problem for an artist right now is payment. We need a fair trade industry ... [the blockchain] could spark up many new platforms and services that would enrich all of our lives"(TechCrunch Disrupt London, 8<sup>th</sup> Dec 2015).
- **Reduced IP costs:** Eleven Advisory (strategy consultant for audio & music & digital media) reported to the British Screen Advisory Board in June that whilst not disposing of the need for lawyers and contracts, this approach could "significantly reduce bureaucracy, paperwork and deal memos that currently need to be put in place around the digitization of virtually all content"—in addition to embedding 'non-invasive' rights management directly into the content.
- **Flexibility and control:** The artist can define conditions in the embedded smart contract around how the sold content should be paid for. Flash sales could be initiated at the artist's discretion, pricing structures defined based on age, or profits automatically siphoned to relief funds reacting to a natural disaster.
- **Data:** Interrogation of blockchain data could give artists valuable data regarding their fans' purchasing habits, listening patterns and possibly location data.

**Figure 99: P2P file sharing decimated physical music revenues through the 00's**

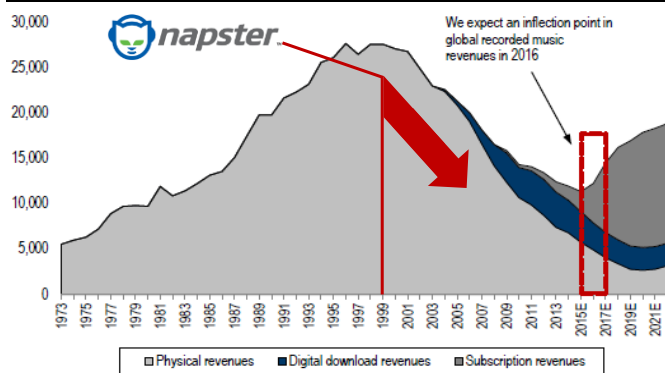

Source: IFPI, Credit Suisse Media Team

**Figure 100: Digital download sales are not projected to experience a material recovery**

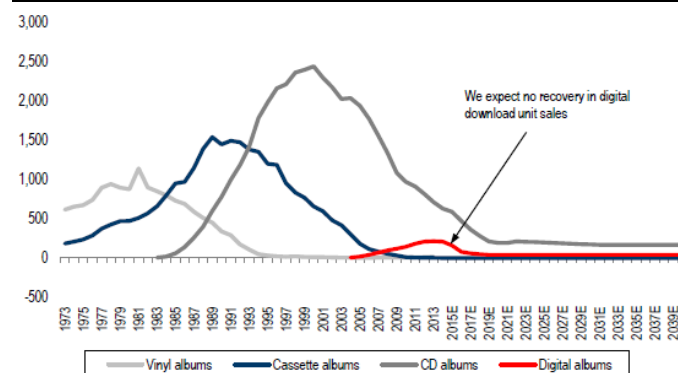

Source: IFPI, Credit Suisse Media Team

Roiled by P2P file sharing in the 2000s, the global music industry's revenues remain under half their peak. We see an inflection point this year as the cost vs convenience relationship of streaming outweighs illegal downloads, and subscription rates increase. There is irony that a protocol borne of P2P may come full circle from enabling the piracy that hit the traditional music business to 1) rendering piracy impossible, and 2) disintermediating the distributors.

Although here we have mainly discussed the use-case for audio, the extension to other content media, particularly video, is natural. Benji Rogers, Founder & CEO of pledge music, for example, proposes a 'fair trade' format whose codec cannot be separated from its rights – media can only be consumed if its integrity is confirmed through a query of the content blockchain, embedded smart contracts then ensure consumption is in line with agreements (number of plays, for example), and rights holders are remunerated in accordance with their ownership rights.

**Figure 101: Fair trade media concept intrinsically binds media to its rights**

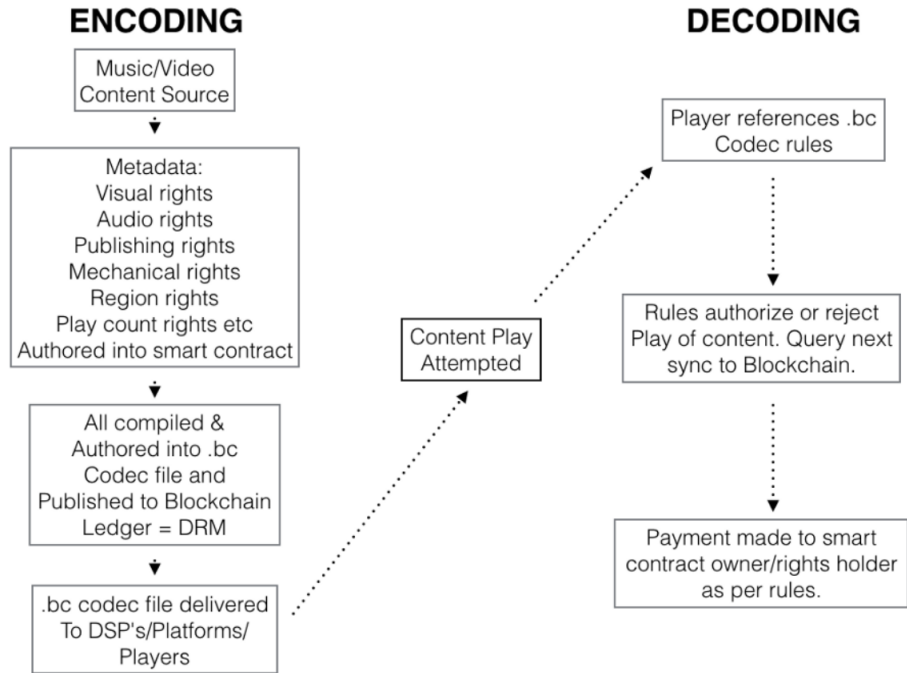

Source: Benji Rogers, Credit Suisse Research

# Analyst View

## Global Media Team

### Market opportunity

We believe the most practical benefit of blockchain technology would be reduction of piracy. Quantifying the potential “piracy opportunity” is challenging and has significant inter-country variance. In 2014 US recorded music revenues were almost \$5bn or c.\$15 per person; this is in contrast to China where revenues in the same year were only \$105m, translating to just \$0.08 per person.

We therefore think the opportunity to reduce piracy is far greater in countries which do not currently have strict IP law enforcement. However, we believe that in order to exploit the opportunity it would require a shift in consumer behavior away from piracy which we do not believe blockchain alone can achieve.

In order to try to quantify the potential impact of a reduction in piracy globally we analyse spend per capita on music, which in 2014 was \$2. Assuming the 4 most populous EM countries (China, India, Indonesia and Brazil) were to increase spend per capita up to the Global average of \$2, this would result in \$6.1bn or 40% incremental revenue for the Global music industry. Clearly this is a very simplistic example which does not account for challenges surrounding IP enforcement in the countries analysed and is heavily skewed by India’s and China’s vast populations and low (\$0.08) spend per capita. However, it illustrates that the potential opportunity for the recorded music industry from even a small reduction in piracy (either through a blockchain-based platform or otherwise) is significant.

**Figure 102: The incremental revenue opportunity if Brazil, India, Indonesia and China adjust to the global mean of \$2 USD is \$5.6bn USD, an increase of 42%**

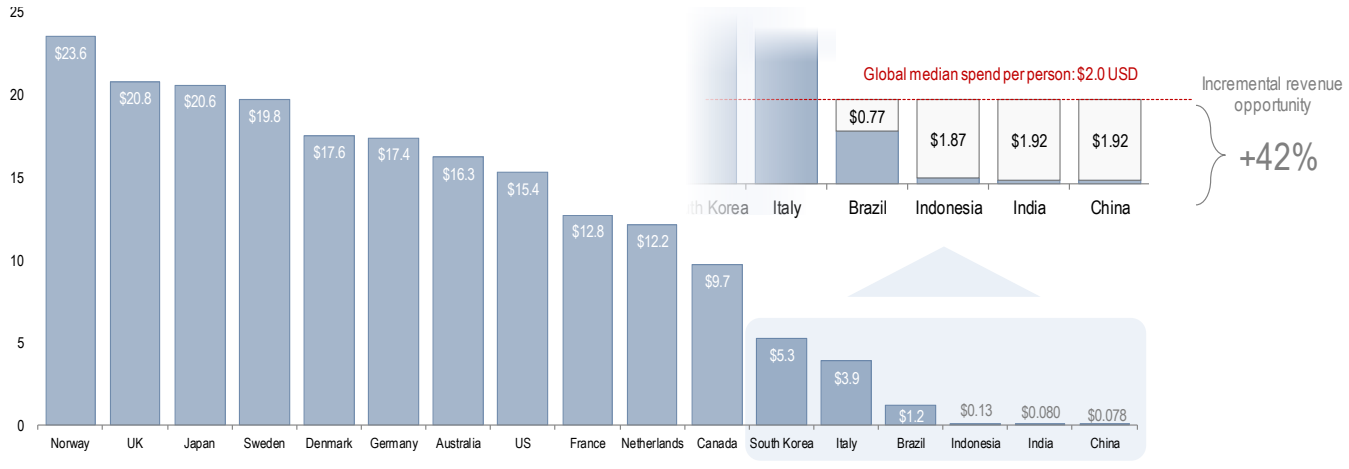

Source: IFPI, World Bank, Credit Suisse Global Media Team, Credit Suisse Research

### Who wins and who loses?

Were a blockchain-based system to appeal to customers, gain traction, and reach critical mass in terms of both users and content – which we see as unlikely short term – we think the main impact would be a reduction (though likely not an elimination) of piracy. This would, in our view benefit the streaming/download platforms (including Apple Music) as the size of the legal music market increased, which in turn would result in increased revenues for the labels/publishers (and in turn artists/writers).

**How likely is this to happen?**

The only way to migrate the music industry (and other content) to a blockchain-based system is total adoption. In our view this is only achievable if:

- There existed an interoperable single data format standard whose codec was intrinsically linked to rights stored on the blockchain. This does not yet exist.
- Credible alternatives for customers in terms of data standard, media player or distribution platform were lacking. Currently this is a competitive and growing arena.

Given the great challenge in retrofitting data format standards, it is suggested that implementation would have to span an entirely new type of media – VR has been proposed. We think this makes full adoption particularly challenging, given that media consumption would have to migrate almost entirely to VR for the format to achieve full penetration.

Suggesting distributors are disintermediated assumes, we think wrongly, that: 1) a new blockchain-based distribution platform is created and is preferred to incumbents by the end user, and 2) that distributors themselves don't move to a blockchain-based model. Given James Duffett-Smith, Spotify's head of Publisher Relations has commented 'we want to fix the global problem of bad publishing data once and for all', we think it unlikely incumbent platforms are disintermediated because of a failure to act.

To interrogate further the first point, we think that any new blockchain-based distribution platform would likely have to be the product of a collaboration of content owners. Historical indications imply that content owners are challenged by collaboration and comprehensive content databases seemingly destined for failure.

The content owners have proved they can't work together; this inability is exemplified by their seeding of current streaming platforms (Spotify, Deezer etc) to ensure a competitive (and therefore cheap) distribution platform.

Content databases have failed before. The International Music Joint Venture IMJV, the International Music Registry IMR, and finally Global Repertoire Database GRD, have all tried, and ultimately largely failed, despite millions in aggregate investment

In sum, while the idea is sound, and we think would reduce piracy in principle, and thus represent an incremental revenue opportunity for content owners, in practice we worry the logistical realities of implementation present an insurmountable challenge, at least on a 5 year view.

**Implications for other Media subsectors**

Although on balance we don't think blockchain is a widely discussed topic by media analysts and investors, the potential to impact the music industry has gained the majority of the limited attention directed towards the technology in media.



We would extend the debate somewhat to other subsectors (which form the bulk of the sector):

#### **Ad-funded TV**

It is hard to see how a blockchain system would disrupt the eco-system for advertising funded TV. Aside from an existing structural move towards SVOD consumption and online video consumption consumers will continue to consume free content on TV. Verified micro-payments for regular TV programmes through the set top box seem unlikely to us (although this might appeal to a minority of viewers if the quid pro quo was the removal of advertising) and any system which still uses free TV aerial communication is not set up for them.

#### **Pay TV/SVOD**

There is a trend for studios (where they are strong and distinctive enough, like Disney and HBO) to go direct to consumers. In a minority of cases where economics are favourable compared to distributor/aggregator payments to content owners, this has also been the route used by sports owners. The content owners selling direct to consumer might find some uses for blockchain, possibly in order to limit piracy, but we believe for the next 5 years at least most content will continue to be sold in the traditional way through the pay TV distributors and SVOD providers which bill consumers through direct debit or credit cards without using blockchain.

#### **Digital video/social networks**

Blockchain could in theory allow content creators to charge consumers directly for content using authenticated micro payments using a kind of digital wallet and allow creators to control distribution of and access to their content. While both professional and user-generated content creators might benefit from making their content part of blockchain, at the moment we do not see any major disturbance to the advertising eco-system as likely. Consumers are still far more likely to view digital video for free on platforms such as Facebook and YouTube, in our view, than they are to pay small amounts for each video they view, even if the charging process is unseen and automatic. Some have suggested that blockchain will allow advertisers such as large FMCG companies to cut down on the amount of advertising they pay for by paying consumers directly through blockchain to trial their products and become brand advocates. However, our view would be that a) this is just another form of below the line promotion and b) heavy advertising would still be necessary to build consumer awareness and for consumers to discover new products.

#### **Publishing**

It is conceivable that newspapers could benefit from micro payments for content/articles hosted on blockchain and this would be a different way of introducing another form of paid model in addition to the monthly or annual digital subscription. However, there is not much evidence so far that consumers would welcome this a la carte model en masse and they are likely to prefer certainty of payment levels in return for unlimited consumption. In addition it is not clear blockchain could do anything to reverse the migration of classified advertising from print to specialised online portals. Therefore the future of the existing dominant online classified businesses is unlikely to be upended through blockchain. For Scientific, Technical and Medical publishing it is possible to see existing publishers using blockchain to host content, take payment from universities and governments and understand reader behaviour, although we would acknowledge existing technologies are capable of these functions. However, it is not likely in our view that scientists and academics will be able to subvert the STM journal publishing industry using payments for individual articles or pieces of research. This is despite the fact that the publishers, like the labels and other intermediaries between music artists and music consumers, take an outsized share of economic value. On balance we believe that blockchain will not overturn the existing economic model because the branded, peer reviewed journal is still needed for prestige, quality control and acquisition of funding and tenure by academics.

**Companies Mentioned** (Price as of 29-Jul-2016)

- ASX** (ASX.AX, A\$49.7, NEUTRAL, TP A\$45.0)
- Apple Inc** (AAPL.OQ, \$104.21)
- Bolsas Y Mercados Espanoles** (BME.MC, €26.86)
- Broadridge** (BR.N, \$67.68)
- CME Group Inc.** (CME.OQ, \$102.24)
- Capita** (CPI.L, 960.0p, NEUTRAL, TP 900.0p)
- Citigroup Inc.** (C.N, \$43.81)
- Computershare** (CPU.AX, A\$8.88, OUTPERFORM, TP A\$10.0)
- DH Corporation** (DH.TO, C\$32.25, OUTPERFORM, TP C\$40.0)
- Deutsche Bank** (DBKGn.F, €12.04)
- Equiniti** (EQN.L, 173.0p, OUTPERFORM[V], TP 210.0p)
- Euronext NV** (ENX.PA, €38.2)
- Experian** (EXP.N, 1477.0p, OUTPERFORM, TP 1505.0p)
- First Data Corporation** (FDC.N, \$12.4)
- Fiserv, Inc.** (FISV.OQ, \$110.36, NEUTRAL, TP \$101.0)
- Goldman Sachs Group, Inc.** (GS.N, \$158.81, OUTPERFORM, TP \$180.0)
- HSBC Holdings** (HSBA.L, 495.1p)
- IntercontinentalExchange, Inc.** (ICE.N, \$264.2)
- JPMorgan Chase & Co.** (JPM.N, \$63.97, OUTPERFORM, TP \$75.0)
- Japan Exchange Group** (8697.T, ¥1,470, UNDERPERFORM, TP ¥995)
- LCH.Clearnet Group** (Unlisted)
- London Stock Exchange** (LSE.L, 2775.0p, OUTPERFORM, TP 2900.0p)
- MasterCard Inc.** (MA.N, \$95.24, OUTPERFORM, TP \$108.0)
- NASDAQ Group Inc.** (NDAQ.OQ, \$70.76, OUTPERFORM, TP \$72.0)
- Northern Trust** (NTRS.OQ, \$67.59)
- Overstock.com** (OSTK.OQ, \$16.3)
- Pfizer** (PFE.N, \$36.89)
- Santander** (SAN.MC, €3.79, NEUTRAL, TP €3.8)
- Standard Chartered Plc** (STAN.L, 604.6p)
- State Street Corp.** (STT.N, \$65.78)
- The Bank of New York Mellon Corp.** (BK.N, \$39.4)
- Visa Inc.** (V.N, \$78.05, OUTPERFORM, TP \$85.0)
- Worldpay** (WPG.L, 293.4p, OUTPERFORM[V], TP 300.0p)

Disclosure Appendix

**Important Global Disclosures**

The analysts identified in this report each certify, with respect to the companies or securities that the individual analyzes, that (1) the views expressed in this report accurately reflect his or her personal views about all of the subject companies and securities and (2) no part of his or her compensation was, is or will be directly or indirectly related to the specific recommendations or views expressed in this report.

**3-Year Price and Rating History for ASX (ASX.AX)**

ASX.AX	Closing Price	Target Price	
Date	(A\$)	(A\$)	Rating
20-Aug-13	35.60	30.00	U
05-Feb-14	34.43	33.20	*
13-Feb-14	36.25	35.20	
19-May-14	36.02	37.00	N
21-Aug-14	37.19	37.00	U
12-Feb-15	39.65	38.00	
08-Apr-15	41.61	43.00	N
20-Aug-15	42.35	42.00	U
04-Sep-15	37.07	40.00	N
06-Jan-16	41.03	40.00	U
11-Feb-16	39.53	40.50	N
05-Apr-16	41.40	41.50	
04-May-16	43.90	43.00	
05-Jul-16	46.21	45.00	

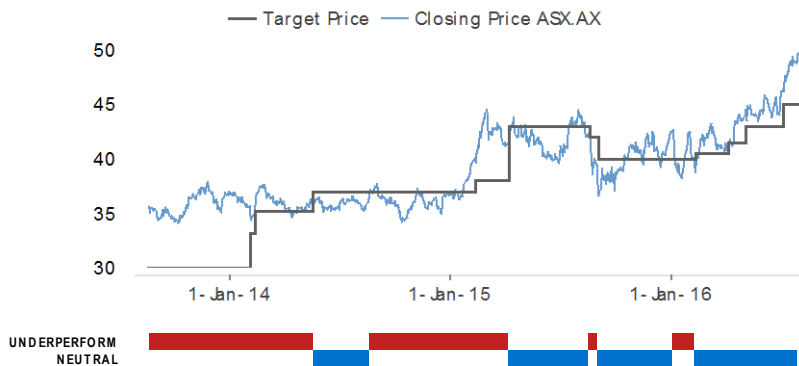

\* Asterisk signifies initiation or assumption of coverage.

3-Year Price and Rating History for Capita (CPI.L)

CPI.L	Closing Price	Target Price	
Date	(p)	(p)	Rating
13-Aug-13	1000.00	1150.00	O
08-May-14	1101.00	1250.00	
01-Aug-14	1180.00	1215.00	N
09-Dec-14	1032.00	1200.00	
10-Mar-15	1154.00	1080.00	U
08-May-15	1238.00	1350.00	O
14-Dec-15	1145.00		R
18-Dec-15	1210.00	1350.00	O
13-May-16	1077.00	1250.00	
28-Jun-16	904.50	900.00	N

\* Asterisk signifies initiation or assumption of coverage.

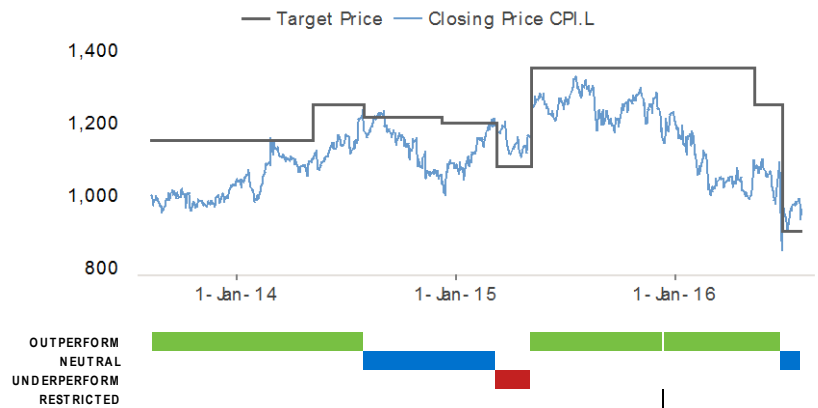

3-Year Price and Rating History for Computershare (CPU.AX)

CPU.AX	Closing Price	Target Price	
Date	(A\$)	(A\$)	Rating
29-Jul-13	9.83	10.80	N
14-Aug-13	9.75	10.50	
16-Oct-13	10.08	11.50	O*
12-Feb-14	11.80	12.60	N
08-Jan-15	11.92	13.60	O
11-Feb-15	11.53	13.40	
15-Apr-15	12.54	13.60	N
17-Jul-15	12.11	13.10	O
12-Aug-15	10.61	12.00	
02-Feb-16	10.85		R
17-May-16	10.40	11.50	O
25-Jul-16	9.16	10.00	

\* Asterisk signifies initiation or assumption of coverage.

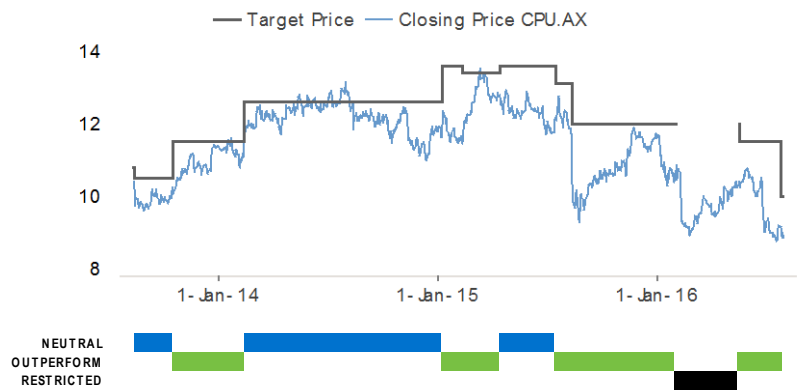

3-Year Price and Rating History for DH Corporation (DH.TO)

DH.TO	Closing Price	Target Price	
Date	(C\$)	(C\$)	Rating
10-Dec-15	31.47	40.00	O*
22-Apr-16	37.27	42.00	
29-Apr-16	32.57	40.00	

\* Asterisk signifies initiation or assumption of coverage.

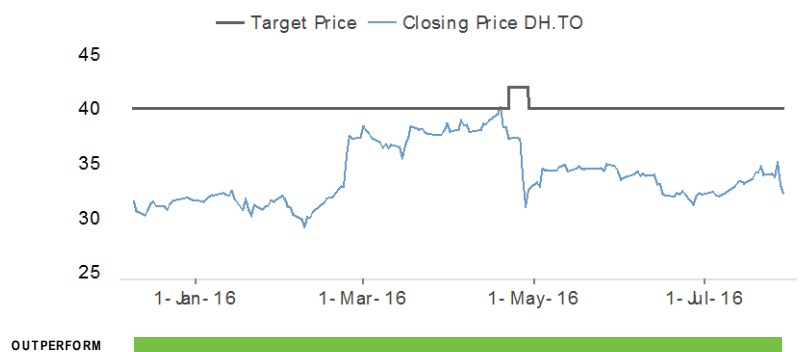

3-Year Price and Rating History for Equiniti (EQN.L)

EQN.L	Closing Price	Target Price	
Date	(p)	(p)	Rating
07-Dec-15	184.00	210.00	O*

\* Asterisk signifies initiation or assumption of coverage.

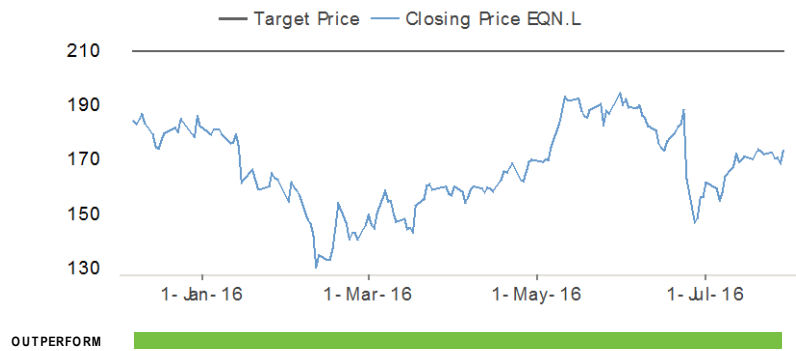

3-Year Price and Rating History for Experian (EXPN.L)

EXPN.L	Closing Price	Target Price	
Date	(p)	(p)	Rating
21-Aug-13	1183.00	1390.00	O
23-Apr-14	1127.00	1230.00	
27-Jun-14	985.50	1100.00	
09-Dec-14	1040.00	1100.00	N
08-Apr-15	1181.00	1300.00	O
19-Apr-16	1290.00	1400.00	
04-Jul-16	1430.00	1505.00	

\* Asterisk signifies initiation or assumption of coverage.

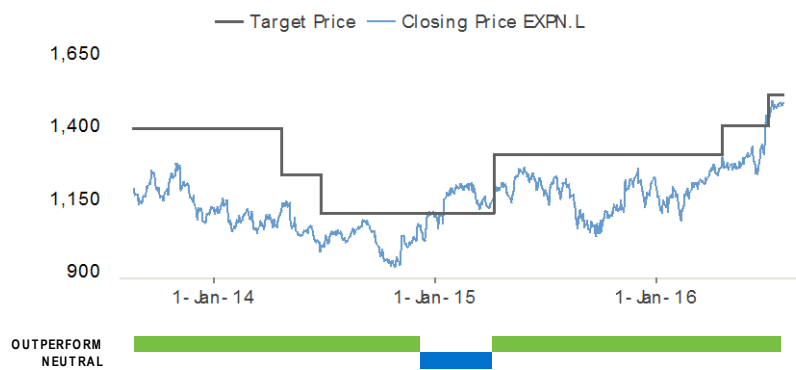

3-Year Price and Rating History for Fiserv, Inc. (FISV.OQ)

FISV.OQ	Closing Price	Target Price	
Date	(US\$)	(US\$)	Rating
31-Jul-13	48.12	45.00	U
05-Feb-14	55.73	53.00	
28-Oct-14	67.26	58.00	
03-Feb-15	74.49	65.00	
05-May-15	77.48	71.00	
29-Jun-15	82.83		NR
10-Dec-15	93.63	100.00	N*
03-Feb-16	94.80	101.00	

\* Asterisk signifies initiation or assumption of coverage.

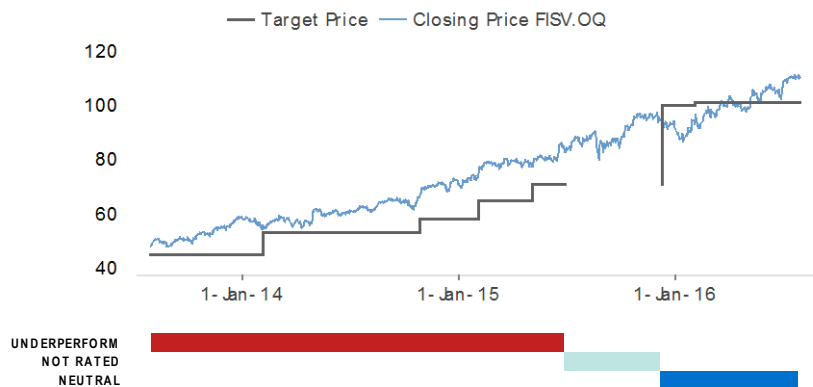

3-Year Price and Rating History for Goldman Sachs Group, Inc. (GS.N)

GS.N	Closing Price	Target Price	
Date	(US\$)	(US\$)	Rating
26-Sep-13	162.29	185.00	O
09-Dec-13	167.67	185.00	*
03-Oct-14	188.07	200.00	
05-Jan-15	188.34	225.00	
02-Jul-15	209.20	245.00	
28-Sep-15	173.02	215.00	
29-Feb-16	149.53	200.00	
30-Mar-16	156.50	180.00	

\* Asterisk signifies initiation or assumption of coverage.

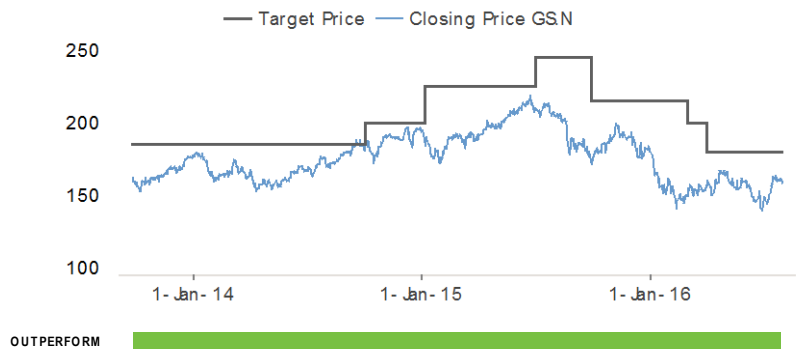

3-Year Price and Rating History for JPMorgan Chase & Co. (JPM.N)

JPM.N	Closing Price	Target Price	
Date	(US\$)	(US\$)	Rating
07-Oct-13	51.83	65.00	O
08-Jan-14	58.87	70.00	
30-Sep-14	60.24		NR
07-Jan-15	59.07	75.00	O*

\* Asterisk signifies initiation or assumption of coverage.

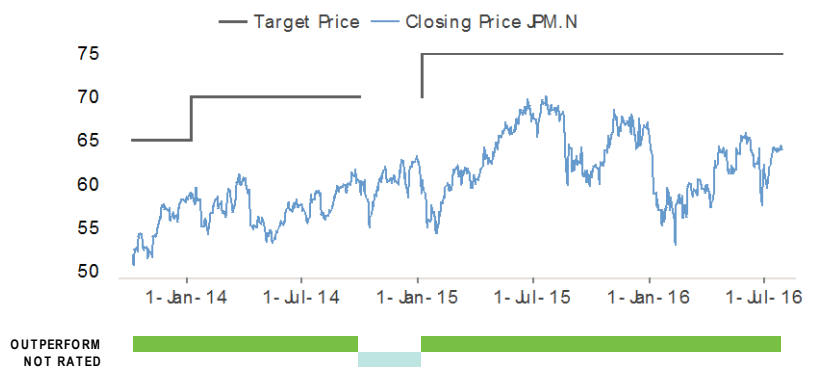

3-Year Price and Rating History for Japan Exchange Group (8697.T)

8697.T	Closing Price	Target Price	
Date	(¥)	(¥)	Rating
05-Aug-13	992	926	U
24-Oct-13	1,080	910	
28-Jan-14	1,263	1,155	
20-Mar-14	1,174	1,040	
30-Apr-14	1,009	900	
25-Aug-14	1,252	1,010	
10-Nov-14	1,496	1,150	
05-Feb-15	1,405	1,165	
07-Jul-15	2,052	1,310	
30-Oct-15	1,964	1,240	
29-Jan-16	1,686	1,352	
23-Mar-16	1,789	1,320	
07-Jun-16	1,349	1,160	
04-Jul-16	1,189	995	

\* Asterisk signifies initiation or assumption of coverage.

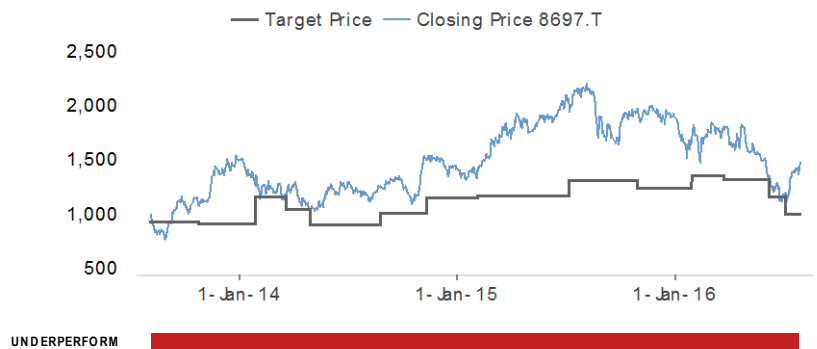

3-Year Price and Rating History for London Stock Exchange (LSE.L)

LSE.L	Closing Price	Target Price	
Date	(p)	(p)	Rating
31-Jul-13	1449.89	1565.96	O
14-Nov-13	1437.92	1639.65	
20-Jan-14	1683.86	1842.30	
21-Mar-14	1822.96	2044.95	
27-Jun-14	1833.09	2164.70	
16-Jul-14	1821.11	2350.00	
31-Jul-14	1785.19		*
08-Apr-15	2550.00	2900.00	O*
07-Mar-16	2836.00	3350.00	
05-May-16	2614.00	2900.00	

\* Asterisk signifies initiation or assumption of coverage.

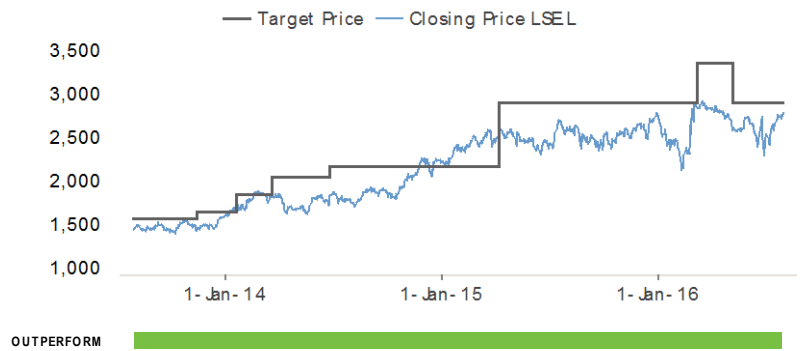

3-Year Price and Rating History for MasterCard Inc. (MA.N)

MA.N	Closing Price	Target Price	
Date	(US\$)	(US\$)	Rating
31-Jul-13	61.06	66.00	O
13-Oct-13	68.42	67.50	
31-Oct-13	71.71	76.00	
11-Dec-13	79.06	81.00	
10-Jan-14	83.48	94.00	
18-Dec-14	86.92	97.00	
07-Apr-15	87.92	100.00	
29-Apr-15	90.25	105.00	
29-Oct-15	100.59	114.00	
29-Jan-16	89.03	108.00	

\* Asterisk signifies initiation or assumption of coverage.

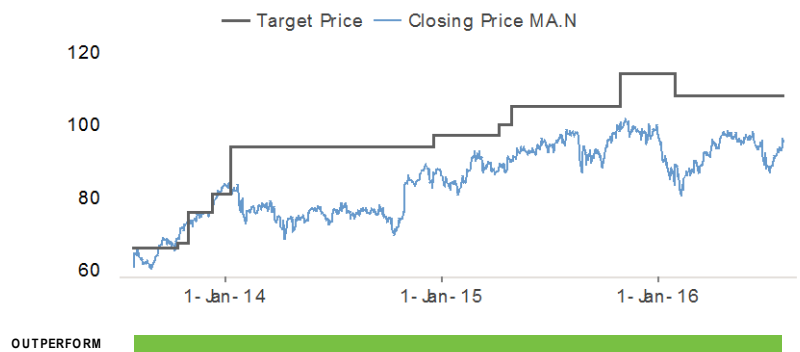

3-Year Price and Rating History for NASDAQ Group Inc. (NDAQ.OQ)

NDAQ.OQ	Closing Price	Target Price	
Date	(US\$)	(US\$)	Rating
08-Oct-13	31.79	33.00	N
23-Oct-13	35.54	35.00	
09-Dec-13	38.91	35.00	*
08-Apr-14	34.81	40.00	
22-Apr-14	36.62	42.00	O
24-Jul-14	42.22	45.00	
24-Oct-14	40.88	44.00	
15-Dec-14	46.46	57.00	
29-Jan-15	45.17	55.00	
22-Oct-15	59.10	59.00	
26-Feb-16	63.85	65.00	
10-Mar-16	64.97	68.00	
27-Jul-16	70.84	72.00	

\* Asterisk signifies initiation or assumption of coverage.

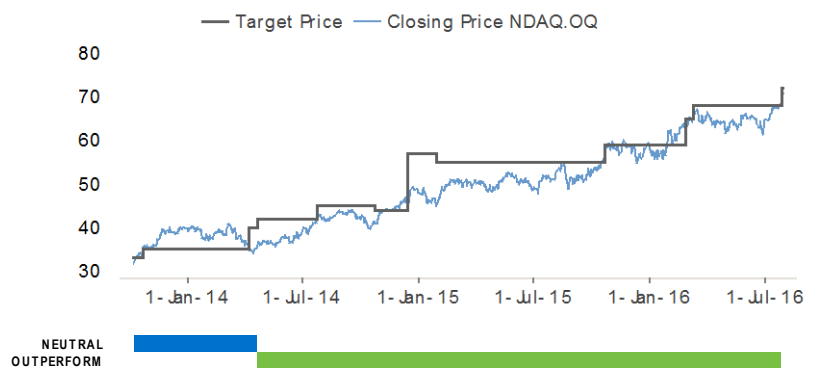

3-Year Price and Rating History for Santander (SAN.MC)

SAN.MC	Closing Price	Target Price	
Date	(€)	(€)	Rating
05-Sep-13	4.74	5.13	N
24-Oct-13	5.85	5.31	
14-Jan-14	6.02	5.43	
28-Jan-14	5.76	5.88	
30-Jan-14	5.82	5.99	
30-Apr-14	6.61	6.38	
01-Aug-14	6.95	6.76	
17-Oct-14	6.54	6.92	
08-Jan-15	6.55	6.31	
10-Feb-15	5.91	6.15	
01-May-15	6.70	6.05	
30-Jul-15	6.23	5.90	
28-Sep-15	4.59		*
22-Oct-15	5.22	5.00	N
21-Jan-16	3.85	4.40	
18-Jul-16	3.81	3.80	

\* Asterisk signifies initiation or assumption of coverage.

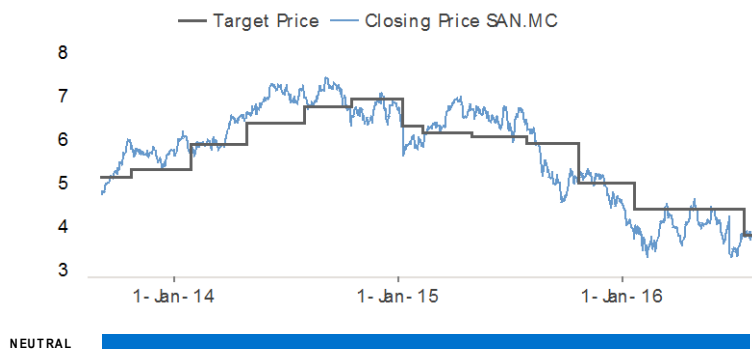

3-Year Price and Rating History for Visa Inc. (V.N)

V.N	Closing Price	Target Price	
Date	(US\$)	(US\$)	Rating
13-Oct-13	48.05	52.50	O
10-Jan-14	55.28	62.50	
29-Oct-14	53.66	65.00	
18-Dec-14	66.04	75.00	
02-Mar-15	69.57	77.50	
23-Jul-15	71.75	82.00	
02-Nov-15	75.22	85.00	
05-Jan-16	76.27	89.00	
28-Jan-16	69.33	85.00	

\* Asterisk signifies initiation or assumption of coverage.

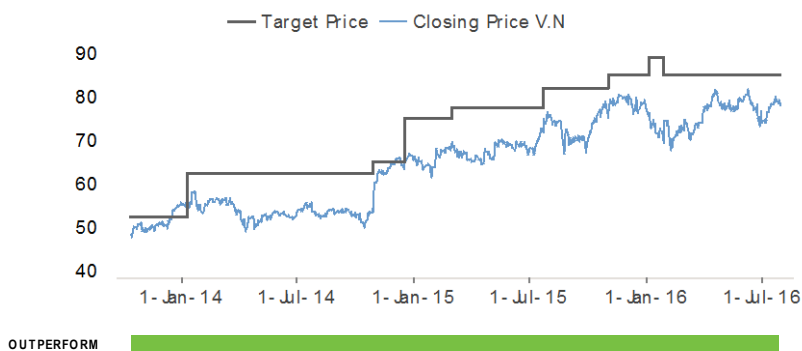

3-Year Price and Rating History for Worldpay (WPG.L)

WPG.L	Closing Price	Target Price	
Date	(p)	(p)	Rating
27-Nov-15	293.50	300.00	N*
18-Apr-16	270.80	300.00	O

\* Asterisk signifies initiation or assumption of coverage.

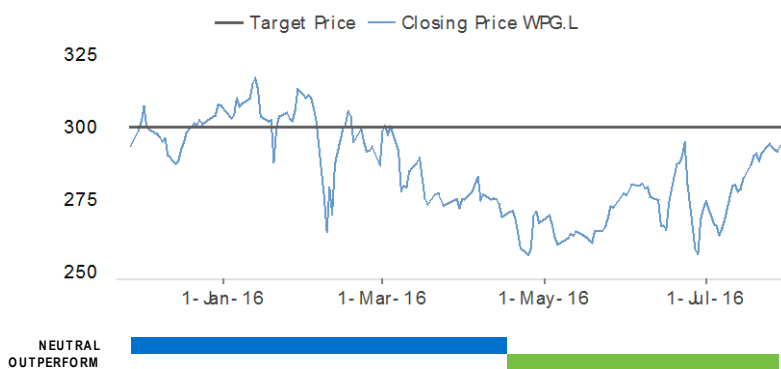

The analyst(s) responsible for preparing this research report received Compensation that is based upon various factors including Credit Suisse's total revenues, a portion of which are generated by Credit Suisse's investment banking activities

As of December 10, 2012 Analysts' stock rating are defined as follows:

**Outperform (O)** : The stock's total return is expected to outperform the relevant benchmark\* over the next 12 months.

**Neutral (N)** : The stock's total return is expected to be in line with the relevant benchmark\* over the next 12 months.

**Underperform (U)** : The stock's total return is expected to underperform the relevant benchmark\* over the next 12 months.

\*Relevant benchmark by region: As of 10th December 2012, Japanese ratings are based on a stock's total return relative to the analyst's coverage universe which consists of all companies covered by the analyst within the relevant sector, with Outperforms representing the most attractive, Neutrals the less attractive, and



Underperforms the least attractive investment opportunities. As of 2nd October 2012, U.S. and Canadian as well as European ratings are based on a stock's total return relative to the analyst's coverage universe which consists of all companies covered by the analyst within the relevant sector, with Outperforms representing the most attractive, Neutrals the less attractive, and Underperforms the least attractive investment opportunities. For Latin American and non-Japan Asia stocks, ratings are based on a stock's total return relative to the average total return of the relevant country or regional benchmark; prior to 2nd October 2012 U.S. and Canadian ratings were based on (1) a stock's absolute total return potential to its current share price and (2) the relative attractiveness of a stock's total return potential within an analyst's coverage universe. For Australian and New Zealand stocks, the expected total return (ETR) calculation includes 12-month rolling dividend yield. An Outperform rating is assigned where an ETR is greater than or equal to 7.5%; Underperform where an ETR less than or equal to 5%. A Neutral may be assigned where the ETR is between -5% and 15%. The overlapping rating range allows analysts to assign a rating that puts ETR in the context of associated risks. Prior to 18 May 2015, ETR ranges for Outperform and Underperform ratings did not overlap with Neutral thresholds between 15% and 7.5%, which was in operation from 7 July 2011.

**Restricted (R)** : In certain circumstances, Credit Suisse policy and/or applicable law and regulations preclude certain types of communications, including an investment recommendation, during the course of Credit Suisse's engagement in an investment banking transaction and in certain other circumstances.

**Not Rated** : Credit Suisse Equity Research does not have an investment rating or view on the stock or any other securities related to the company at this time.

**Not Covered (NC)** : Credit Suisse Equity Research does not provide ongoing coverage of the company or offer an investment rating or investment view on the equity security of the company or related products.

**Volatility Indicator [V]** : A stock is defined as volatile if the stock price has moved up or down by 20% or more in a month in at least 8 of the past 24 months or the analyst expects significant volatility going forward.

Analysts' sector weightings are distinct from analysts' stock ratings and are based on the analyst's expectations for the fundamentals and/or valuation of the sector\* relative to the group's historic fundamentals and/or valuation:

**Overweight** : The analyst's expectation for the sector's fundamentals and/or valuation is favorable over the next 12 months.

**Market Weight** : The analyst's expectation for the sector's fundamentals and/or valuation is neutral over the next 12 months.

**Underweight** : The analyst's expectation for the sector's fundamentals and/or valuation is cautious over the next 12 months.

\*An analyst's coverage sector consists of all companies covered by the analyst within the relevant sector. An analyst may cover multiple sectors.

Credit Suisse's distribution of stock ratings (and banking clients) is:

#### Global Ratings Distribution

Rating	Versus universe (%)	Of which banking clients (%)
Outperform/Buy*	53%	(45% banking clients)
Neutral/Hold*	31%	(13% banking clients)
Underperform/Sell*	15%	(33% banking clients)
Restricted	1%	

\*For purposes of the NYSE and NASD ratings distribution disclosure requirements, our stock ratings of Outperform, Neutral, and Underperform most closely correspond to Buy, Hold, and Sell, respectively; however, the meanings are not the same, as our stock ratings are determined on a relative basis. (Please refer to definitions above.) An investor's decision to buy or sell a security should be based on investment objectives, current holdings, and other individual factors.

Credit Suisse's policy is to update research reports as it deems appropriate, based on developments with the subject company, the sector or the market that may have a material impact on the research views or opinions stated herein.

Credit Suisse's policy is only to publish investment research that is impartial, independent, clear, fair and not misleading. For more detail please refer to Credit Suisse's Policies for Managing Conflicts of Interest in connection with Investment Research: [http://www.csfb.com/research-and-analytics/disclaimer/managing\\_conflicts\\_disclaimer.html](http://www.csfb.com/research-and-analytics/disclaimer/managing_conflicts_disclaimer.html)

Credit Suisse does not provide any tax advice. Any statement herein regarding any US federal tax is not intended or written to be used, and cannot be used, by any taxpayer for the purposes of avoiding any penalties.

#### Target Price and Rating

##### Valuation Methodology and Risks: (12 months) for ASX (ASX.AX)

**Method:** We set our target price of \$45.00 for ASX using the average of our DCF (equity beta of 0.9, a risk free rate of 4.0%, a market risk premium of 6.0% and a terminal growth rate of 3.5%) and a PE relative (25% market premium). While the growth outlook for ASX is only modest, we note that there is valuation support for ASX given its defensive earnings. Given the challenging markets, we believe the low earnings risk that ASX offers is worth a P/E premium and so have an Neutral rating.

**Risk:** We consider main risks to ASX achieving our target price of \$45.00 and Neutral rating to be : 1) sustained equity market weakness; 2) number and value of equity and derivative trades; 3) level of capital raisings/IPOs; 4) its ability to maintain strong cost control; 5) competition; 6) regulatory environment; and 7) potential upside risk from a takeover offer.

#### Target Price and Rating

##### Valuation Methodology and Risks: (12 months) for Capita (CPI.L)

**Method:** Our 900p target price is set by reference to DCF analysis using risk free rate of 2.0% and equity risk premium of 6.5%. DCF applies a 10 year competitive advantage period before fading RoNA towards the WACC. In addition to this organic DCF we include the value of future acquisitions in a separate DCF. However, given elevated risks to the top line due to Brexit uncertainties, confidence in the investment case has fallen sharply and we see the shares as broadly fairly valued. Hence our Neutral rating.

**Risk:** Upside risks to our target price and rating include: Further contract wins and acquisitions; stronger transactional and project revenue growth than anticipated; higher inflation than expected; new contracts prove to be less margin dilutive than expected. Downside: Further

contract losses/attrition; contract delays; increasing competition from SMEs and overseas IT Services and Outsourcing companies; and significant disruption to growth prospects in the UK and Europe due to Brexit uncertainties.

#### Target Price and Rating

##### Valuation Methodology and Risks: (12 months) for Computershare (CPU.AX)

**Method:** We set our target price of A\$10.00 for CPU using a blended (50/50) PE and discounted cashflow methodology based on a beta of 0.90 and a terminal growth rate of 2.0%, a 10yr bond rate of 5.0%, a market risk premium of 6.0% and a target gearing level of 15%. Our PE is based on a 10% discount to the market. We have an Outperform rating on CPU as the stock is trading at a significant discount to the market and we think it deserves a market multiple given a large part of its earnings are high quality and recurring in nature.

**Risk:** The risks to our A\$10.00 target price and Outperform rating for CPU include: 1) significant fall in global corporate activity; 2) pricing competition in the US; 3) execution risks; and 4) economic/interest rate/currency risk.

#### Target Price and Rating

##### Valuation Methodology and Risks: (12 months) for DH Corporation (DH.TO)

**Method:** Our \$40 target price is derived from a blended P/E and EV/EBITDA valuation and implies a 2017 P/E multiple of 16x and EV/EBITDA multiple of 12x. We note given its different tax jurisdiction, some investors prefer to use only EV/EBITDA for comparison multiples. Our Outperform rating relates to our view that DH is a relatively low-price stock given stability of its business, though we note it is approaching our price target.

**Risk:** Risks to our \$40 Target Price include slow end-market growth in core-processing and check issuance, competition in lending automation and core processing markets, leverage of 3x as of 3Q15 restricting capital allocation options, loss in 2016 of Canada student loan servicing contract currenting generating 8-10% of revenues, and margin contraction from lower-margin Fundtech acquisition. Risks to our Outperform rating include a slow-down in end markets and the fact the stock is approaching our price target.

#### Target Price and Rating

##### Valuation Methodology and Risks: (12 months) for Equiniti (EQN.L)

**Method:** Our target price of 210p is set using a DCF approach using a risk free rate of 2.0%, a market risk premium of 6.5%. We combine an organic valuation of 188p with the value of future acquisitions of 22p. We rate the stock as Outperform due to the material upside potential to our TP and the significant valuation gap to listed peers, which we think can close over time.

**Risk:** Upside risks to our target price and rating include: Further value creative and accretive acquisitions; an acceleration in the level of 'Corporate Actions' earnings; a material rise in UK interest rates; substantially higher levels of project work, especially in Pensions Solutions; strong trading in transactional revenues including retail share dealing. Downside: A lack of replacement project work in Pension Solutions and Intelligent Solutions; higher-than-forecast restructuring and reorganisation charges; churn in the core Registration Services business away from retail investor-heavy registers; cost increases mandated by new regulations; longer term demographic shifts away from direct share ownership; higher-than-forecast short-term business development costs (esp. into public sector BPO).

#### Target Price and Rating

##### Valuation Methodology and Risks: (12 months) for Experian (EXP.N.L)

**Method:** Our target price of 1505p is based on our DCF methodology, in line with the rest of the sector. Our organic DCF uses a WACC of 6.6% in 2017 based on a risk free rate of 2% and 6.5% market risk premium. We use 5 years of explicit forecasts then reduce RoNA to sustainable mid-cycle levels for the subsequent 5 years. Thereafter we fade RoNA towards the WACC at 10% of the difference between RoNA and WACC per year. In addition we include the value of future acquisitions to reflect the company's M&A strategy. We rate Experian Outperform because we do not think the current share price reflects the cash generation or the sustainability of RoNA for the business in either the short or medium term.

**Risk:** Risk factors that could positively impact our price target and rating include: more operational gearing than we forecast in the cyclical segments of the business; value creative use of the balance sheet, benefits from expansion of product suite into the international business, recovery in Consumer Services. Risk factors that could negatively impact our price target and rating include: legislation, data breach, prolonged weakness in the latin american division, competitive threats in the Consumer Services division, weakness in email marketing.

#### Target Price and Rating

##### Valuation Methodology and Risks: (12 months) for Fiserv, Inc. (FISV.OQ)

**Method:** Our \$101 target price is derived from a blended P/E and EV/EBITDA valuation and implies a 2017 P/E multiple of 20x and EV/EBITDA multiple of 13x. We believe FISV should continue to trade at a relative premium given expectations for margin expansion and steady highly visible results, although we note it trades well above its historical average P/E in the mid-teens. Our Neutral rating is owing to the fact that we see little multiple expansion from current levels.

**Risk:** Risks to our \$101 target price and include bank consolidation leading to deconversions or decreasing potential customer base, inability to expand margins, inability to cross-sell from slowdown in product development cycle, and data theft or breach of sensitive client-bank

information. Risks to our Neutral rating include better than, or worse than expected performance results related to any of the price target risks mentioned above, which could drive meaningful stock appreciation or contraction, respectively.

#### Target Price and Rating

##### Valuation Methodology and Risks: (12 months) for Goldman Sachs Group, Inc. (GS.N)

**Method:** Our current target price is \$180. This valuation is based on 0.9x forecast 2017 BV and 11x 2017 EPS. We rate GS shares Outperform. Our current rating is based on relative upside within our brokerage universe.

**Risk:** Risks to our \$180 target price and Outperform rating for Goldman Sachs are weaker than expected global economic growth and market conditions, management turnover, litigation risk, and more onerous regulation.

#### Target Price and Rating

##### Valuation Methodology and Risks: (12 months) for JPMorgan Chase & Co. (JPM.N)

**Method:** We arrive at our \$75 target price for JPM using a discounted cash flow analysis. We assume an 11% cost of capital and a 3% terminal growth rate in our analysis; near term target CET 1 fully phased in capital levels impact free cash flow analysis. A \$75 valuation for JPM implies an estimated price to forecast year end 2015 book value of 1.2x in 2015, which we believe to be reasonable given our forecast ROEs both absolute and relative to peers. Valuation and total return potential drive our Outperform rating. Beyond valuation and implied total return, additional qualitative factors supporting confidence in the assumptions underlying our valuation and Outperform rating include balance sheet optimization progress and prospects, above-average organic revenue growth, operating leverage, and above-average returns.

**Risk:** Primary risks to our \$75 target price and Outperform rating include macroeconomic risk, increasing regulatory pressure, litigation and related costs, and cybersecurity. Additional risks specific to JPM include competing with a higher GSIB capital surcharge, a forced reduction in complexity, and management succession.

#### Target Price and Rating

##### Valuation Methodology and Risks: (12 months) for Japan Exchange Group (8697.T)

**Method:** Our ¥995 target price for Japan Exchange Group is based on a theoretical P/B of 1.95x applied to our FY3/17E BPS of ¥509.8, using forecast ROE of 15.2% and a discount rate of 7.76% based on 0% risk free rate, 6.75% ERP and 1.15 Beta. The profit level has not been reflected in the share price, in our view, due to the high correlation between the absolute share price and stock market prices. We are convinced investors have overvalued the shares in expectation of a rise of Japanese stocks. Our UNDERPERFORM rating reflects our 12-month outlook for total returns and comparison with our coverage universe.

**Risk:** Risks to our ¥995 target price and UNDERPERFORM rating for Japan Exchange Group include the following: If the share price continues to be formed based on the stock market level, rather than market trading value (which is an earnings variation factor), the risk of overvaluation remains while investors anticipate a rise. Tax reforms in or after autumn this year, which could lead to a rise in individual investors' derivative transactions, is also a risk.

#### Target Price and Rating

##### Valuation Methodology and Risks: (12 months) for London Stock Exchange (LSE.L)

**Method:** We value LSE using a DCF model which incorporates our explicit forecasts until 2018, a medium term growth assumption of 8.0% and a long-term growth assumption of 3.0%. We discount cash flows using a WACC of 8.5% derived from a cost of equity of 9.0% (2.0% risk free rate, 7.0% equity risk premium & 6.0% long-term cost of debt). This results in a valuation of 2,904p which we round down to derive our price target of 2,900p. Given the upside to our price target we rate the stock Outperform.

**Risk:** The risk factors that could impede achievement of our 2,900p target price and cause us to lower our rating from Outperform are: (1) variation from our volume growth forecasts; (2) regulatory change (e.g. material changes to CCP regulatory capital needs); (3) introduction of an EU FTT negatively impacting LCH clearing volumes; (4) corporate restructuring; (5) unexpected senior management changes and (6) antitrust risks resulting from the proposed combination with DB1.

#### Target Price and Rating

##### Valuation Methodology and Risks: (12 months) for MasterCard Inc. (MA.N)

**Method:** Our Outperform rating and \$108 target price for MasterCard represent ~25x our C'17 EPS estimate. We believe this valuation is justified given that MasterCard has demonstrated the ability to grow through the slowing of spending volumes. Since 2012 MasterCard has traded of 17x-27x forward PE. We believe that MasterCard deserves a significant premium over the market multiple due to the network's strong organic growth and sustainable business model. Given the upside potential indicated by our target price, we rate the stock Outperform.

**Risk:** The primary risks for our Outperform rating and \$108 target price on MasterCard are reduced spending or increased price competition stemming from the effects of the Fed's recent Durbin Amendment ruling. Another potential risk to our rating would entail significant market share competition in the U.S. and Europe.

#### Target Price and Rating

##### Valuation Methodology and Risks: (12 months) for NASDAQ Group Inc. (NDAQ.OQ)

**Method:** Our \$72 target price for NDAQ is 17x our 2017 EPS estimate (incl. \$3.00 free option from Canada and NLX/NFX initiatives hitting break-even). Our Outperform rating is underpinned by total return potential relative to peers driven by sustained organic growth, increasing operating leverage, high FCF generation (~7% FCF yield) and an aggressive capital return policy.

**Risk:** Risks to our \$72 NDAQ target price and Outperform rating are a decline in trading activity in global cash equities or options trading volume, as well as sudden shifts or disruptions in the underlying markets. The company faces competition within both its U.S. and European trading, market data, and listings businesses which may result in lost market share and pricing pressure. As the operator of multiple regulated financial exchanges, NDAQ is subject to extensive regulatory oversight globally. The company's results may also be at risk due to unforeseen developments as a result of U.S. or European market structure reform. Company results are also at risk to the extent that the company cannot successfully integrate current or future acquisitions.

#### Target Price and Rating

##### Valuation Methodology and Risks: (12 months) for Santander (SAN.MC)

**Method:** Our target price is derived using a traditional P/BV (RoTBV/CoE) methodology, applying an 11% CoE and a 2.3% growth rate to the bank's 2017E RoTBV. We have a Neutral rating on the stock, as we believe the market is fairly valuing it on the basis of its returns and comparatively lower solvency levels.

**Risk:** The main risks to our target price and Neutral rating are (i) a sharp deterioration of Brazil's economic outlook, (ii) additional capital needs derived from increased regulatory requirements, (iii) a slowdown in the recovery of European economies

#### Target Price and Rating

##### Valuation Methodology and Risks: (12 months) for Visa Inc. (V.N)

**Method:** Our Outperform rating and \$85 target price for Visa represent ~25x our C'17 EPS estimate. We expect the company to recapture most of its debit market share through new pricing and keep rapidly expanding its international business. Visa has demonstrated ability to enhance margins if weaker economic activity leads to slower revenue growth. Given the upside potential indicated by our target price, we rate the stock Outperform.

**Risk:** The primary risk to our Outperform rating and \$85 target for Visa is a reduction in spending or an increase in pricing competition as a result of the recently passed card legislation. Another risk would include challenges increasing pricing in Europe. Visa recently purchased Visa Europe and we estimate that management must raise European pricing by ~50% to achieve their accretion guidance.

#### Target Price and Rating

##### Valuation Methodology and Risks: (12 months) for Worldpay (WPG.L)

**Method:** We value Worldpay in line with other growth assets, both in the broader UK market and across European tech peers. This supports a target PE of 24x, or 300p per share. Given the upside potential, we have an Outperform rating.

**Risk:** The key downside risk to our PE-derived Outperform rating and target price is further slippage in the US that could negatively impact profits.

Please refer to the firm's disclosure website at <https://rave.credit-suisse.com/disclosures> for the definitions of abbreviations typically used in the target price method and risk sections.

*See the Companies Mentioned section for full company names*

The subject company (NDAQ.OQ, DH.TO, GS.N, FISV.OQ, SAN.MC, EQN.L, WPG.L, JPM.N, C.N, PFE.N, STT.N, FDC.N, AAPL.OQ, BK.N, NTRS.OQ, STAN.L, BME.MC, CME.OQ) currently is, or was during the 12-month period preceding the date of distribution of this report, a client of Credit Suisse.

Credit Suisse provided investment banking services to the subject company (DH.TO, GS.N, FISV.OQ, SAN.MC, EQN.L, WPG.L, JPM.N, C.N, PFE.N, STT.N, FDC.N, AAPL.OQ, BK.N, STAN.L) within the past 12 months.

Credit Suisse provided non-investment banking services to the subject company (GS.N, FISV.OQ, SAN.MC, EQN.L, JPM.N, C.N, STT.N, FDC.N, BK.N, STAN.L) within the past 12 months

Credit Suisse has managed or co-managed a public offering of securities for the subject company (GS.N, SAN.MC, EQN.L, WPG.L, JPM.N, C.N, PFE.N, STT.N, FDC.N, AAPL.OQ, BK.N, STAN.L) within the past 12 months.

Credit Suisse has received investment banking related compensation from the subject company (DH.TO, GS.N, FISV.OQ, SAN.MC, EQN.L, WPG.L, JPM.N, C.N, PFE.N, STT.N, FDC.N, AAPL.OQ, BK.N, STAN.L) within the past 12 months

Credit Suisse expects to receive or intends to seek investment banking related compensation from the subject company (NDAQ.OQ, CPU.AX, DH.TO, GS.N, FISV.OQ, SAN.MC, EQN.L, WPG.L, JPM.N, V.N, C.N, PFE.N, STT.N, FDC.N, AAPL.OQ, BK.N, STAN.L, BME.MC, CME.OQ) within the next 3 months.

Credit Suisse has received compensation for products and services other than investment banking services from the subject company (GS.N, FISV.OQ, SAN.MC, EQN.L, JPM.N, C.N, STT.N, FDC.N, BK.N, STAN.L) within the past 12 months

As of the date of this report, Credit Suisse makes a market in the following subject companies (NDAQ.OQ, GS.N, FISV.OQ, JPM.N, V.N, C.N, PFE.N, STT.N, AAPL.OQ, BK.N, NTRS.OQ, CME.OQ, ICE.N).

As of the end of the preceding month, Credit Suisse beneficially own 1% or more of a class of common equity securities of (EXP.N, LSE.L, STAN.L).

Credit Suisse has a material conflict of interest with the subject company (CPU.AX). Credit Suisse is acting as the financial advisor to UK Asset Resolution Limited for the divestment of its mortgage servicing activities to Computershare Limited.



Credit Suisse has a material conflict of interest with the subject company (CPI.L) . Gillian Sheldon, a Senior Advisor of Credit Suisse, is a board member of Capita Plc (CPI.L).

Credit Suisse has a material conflict of interest with the subject company (C.N) . Credit Suisse is acting as a financial advisor for Springleaf in relation to the acquisition of OneMain Financial from CitiFinancial Credit Company, a wholly-owned subsidiary of Citigroup.

Credit Suisse has a material conflict of interest with the subject company (STT.N) . Credit Suisse is acting as exclusive financial advisor to State Street (STT.N) on their acquisition of General Electric Asset Management (GEAM).

Credit Suisse has a material conflict of interest with the subject company (ICE.N) . Credit Suisse acted as a principal advisor to Interactive Data Corporation in Intercontinental Exchange's acquisition of Interactive Data Corporation.

As of the date of this report, an analyst involved in the preparation of this report has the following material conflict of interest with the subject company (JPM.N). As of the date of this report, an analyst involved in the preparation of this report, Susan Katzke, has following material conflicts of interest with the subject company. The analyst or a member of the analyst's household has a long position in the common and preferred stock JPMorgan Chase & Co (JPM).

As of the date of this report, an analyst involved in the preparation of this report has the following material conflict of interest with the subject company (C.N). As of the date of this report, an analyst involved in the preparation of this report, Susan Katzke, has following material conflicts of interest with the subject company. The analyst or a member of the analyst's household has a long position in the common and preferred stock Citigroup (C).

As of the date of this report, an analyst involved in the preparation of this report has the following material conflict of interest with the subject company (PFE.N). As of the date of this report, an analyst involved in the preparation of this report, Vamil Divan, has following material conflicts of interest with the subject company. The analyst or a member of the analyst's household has a long position in the common stock Pfizer (PFE.N). A member of the analyst's household is an employee of Pfizer (PFE.N).

For other important disclosures concerning companies featured in this report, including price charts, please visit the website at <https://rave.credit-suisse.com/disclosures> or call +1 (877) 291-2683.

For a history of recommendations for the subject company(ies) featured in this report, disseminated within the past 12 months, please refer to <https://rave.credit-suisse.com/disclosures/view/report?i=240552&v=-4a8aq2rzdcqn5pouvqr7mbizi>.

### Important Regional Disclosures

Singapore recipients should contact Credit Suisse AG, Singapore Branch for any matters arising from this research report.

The analyst(s) involved in the preparation of this report may participate in events hosted by the subject company, including site visits. Credit Suisse does not accept or permit analysts to accept payment or reimbursement for travel expenses associated with these events.

Restrictions on certain Canadian securities are indicated by the following abbreviations: NVS--Non-Voting shares; RVS--Restricted Voting Shares; SVS--Subordinate Voting Shares.

Individuals receiving this report from a Canadian investment dealer that is not affiliated with Credit Suisse should be advised that this report may not contain regulatory disclosures the non-affiliated Canadian investment dealer would be required to make if this were its own report.

For Credit Suisse Securities (Canada), Inc.'s policies and procedures regarding the dissemination of equity research, please visit <https://www.credit-suisse.com/sites/disclaimers-ib/en/canada-research-policy.html>.

The following disclosed European company/ies have estimates that comply with IFRS: (EXP.N.L, SAN.MC, LSE.L, STAN.L).

Credit Suisse has acted as lead manager or syndicate member in a public offering of securities for the subject company (GS.N, FISV.OQ, SAN.MC, EQN.L, WPG.L, JPM.N, C.N, PFE.N, STT.N, FDC.N, AAPL.OQ, BK.N, STAN.L, CME.OQ) within the past 3 years.

As of the date of this report, Credit Suisse acts as a market maker or liquidity provider in the equities securities that are the subject of this report.

Principal is not guaranteed in the case of equities because equity prices are variable.

Commission is the commission rate or the amount agreed with a customer when setting up an account or at any time after that.

This research report is authored by:

**Credit Suisse Securities (Japan) Limited**..... Takehito Yamanaka ; Kenya Goto

**Credit Suisse Securities (USA) LLC**Ashley N. Serrao, CFA ; Christian Bolu ; Richard Fellingner ; Omar Sheikh ; Lawrence Dann-Fenwick ; Susan Roth Katzke ; Athena Xie ; Moshe Orenbuch ; Paul Condra ; James Ulan ; Mrinalini Bhutoria ; Marcus Carney

**Credit Suisse International**William Lunn ; Charles Brennan CFA ; Martin Price ; Sophie Bell ; Joseph Barnet-Lamb ; Tom Mills ; Karl Green ; Andy Grobler, CFA ; Andrea Unzueta ; Hugo Swann ; David Da Wei Wong ; Daniel Hobden

**Credit Suisse Equities (Australia) Limited**..... Andrew Adams ; James Cordukes, CFA

To the extent this is a report authored in whole or in part by a non-U.S. analyst and is made available in the U.S., the following are important disclosures regarding any non-U.S. analyst contributors: The non-U.S. research analysts listed below (if any) are not registered/qualified as research analysts with FINRA. The non-U.S. research analysts listed below may not be associated persons of CSSU and therefore may not be subject to the NASD Rule 2711 and NYSE Rule 472 restrictions on communications with a subject company, public appearances and trading securities held by a research analyst account.

**Credit Suisse Securities (Japan) Limited**..... Takehito Yamanaka

**Credit Suisse International**William Lunn ; Charles Brennan CFA ; Martin Price ; Sophie Bell ; Joseph Barnet-Lamb ; Tom Mills ; Karl Green ; Andy Grobler, CFA ; Andrea Unzueta ; Hugo Swann ; David Da Wei Wong

**Credit Suisse Equities (Australia) Limited**..... Andrew Adams ; James Cordukes, CFA

### Important Credit Suisse HOLT Disclosures

With respect to the analysis in this report based on the Credit Suisse HOLT methodology, Credit Suisse certifies that (1) the views expressed in this report accurately reflect the Credit Suisse HOLT methodology and (2) no part of the Firm's compensation was, is, or will be directly related to the specific views disclosed in this report.

The Credit Suisse HOLT methodology does not assign ratings to a security. It is an analytical tool that involves use of a set of proprietary quantitative algorithms and warranted value calculations, collectively called the Credit Suisse HOLT valuation model, that are consistently applied to all the companies included in its database. Third-party data (including consensus earnings estimates) are systematically translated into a number of default

algorithms available in the Credit Suisse HOLT valuation model. The source financial statement, pricing, and earnings data provided by outside data vendors are subject to quality control and may also be adjusted to more closely measure the underlying economics of firm performance. The adjustments provide consistency when analyzing a single company across time, or analyzing multiple companies across industries or national borders. The default scenario that is produced by the Credit Suisse HOLT valuation model establishes the baseline valuation for a security, and a user then may adjust the default variables to produce alternative scenarios, any of which could occur.

Additional information about the Credit Suisse HOLT methodology is available on request.

The Credit Suisse HOLT methodology does not assign a price target to a security. The default scenario that is produced by the Credit Suisse HOLT valuation model establishes a warranted price for a security, and as the third-party data are updated, the warranted price may also change. The default variable may also be adjusted to produce alternative warranted prices, any of which could occur.

CFROI®, HOLT, HOLTfolio, ValueSearch, AggreGator, Signal Flag and “Powered by HOLT” are trademarks or service marks or registered trademarks or registered service marks of Credit Suisse or its affiliates in the United States and other countries. HOLT is a corporate performance and valuation advisory service of Credit Suisse.

---

For Credit Suisse disclosure information on other companies mentioned in this report, please visit the website at <https://rave.credit-suisse.com/disclosures> or call +1 (877) 291-2683.

---

This report is produced by subsidiaries and affiliates of Credit Suisse operating under its Global Markets Division. For more information on our structure, please use the following link: <https://www.credit-suisse.com/who-we-are>

This report may contain material that is not directed to, or intended for distribution to or use by, any person or entity who is a citizen or resident of or located in any locality, state, country or other jurisdiction where such distribution, publication, availability or use would be contrary to law or regulation or which would subject Credit Suisse or its affiliates ("CS") to any registration or licensing requirement within such jurisdiction. All material presented in this report, unless specifically indicated otherwise, is under copyright to CS. None of the material, nor its content, nor any copy of it, may be altered in any way, transmitted to, copied or distributed to any other party, without the prior express written permission of CS. All trademarks, service marks and logos used in this report are trademarks or service marks or registered trademarks or service marks of CS or its affiliates. The information, tools and material presented in this report are provided to you for information purposes only and are not to be used or considered as an offer or the solicitation of an offer to sell or to buy or subscribe for securities or other financial instruments. CS may not have taken any steps to ensure that the securities referred to in this report are suitable for any particular investor. CS will not treat recipients of this report as its customers by virtue of their receiving this report. The investments and services contained or referred to in this report may not be suitable for you and it is recommended that you consult an independent investment advisor if you are in doubt about such investments or investment services. Nothing in this report constitutes investment, legal, accounting or tax advice, or a representation that any investment or strategy is suitable or appropriate to your individual circumstances, or otherwise constitutes a personal recommendation to you. CS does not advise on the tax consequences of investments and you are advised to contact an independent tax adviser. Please note in particular that the bases and levels of taxation may change. Information and opinions presented in this report have been obtained or derived from sources believed by CS to be reliable, but CS makes no representation as to their accuracy or completeness. CS accepts no liability for loss arising from the use of the material presented in this report, except that this exclusion of liability does not apply to the extent that such liability arises under specific statutes or regulations applicable to CS. This report is not to be relied upon in substitution for the exercise of independent judgment. CS may have issued, and may in the future issue, other communications that are inconsistent with, and reach different conclusions from, the information presented in this report. Those communications reflect the different assumptions, views and analytical methods of the analysts who prepared them and CS is under no obligation to ensure that such other communications are brought to the attention of any recipient of this report. Some investments referred to in this report will be offered solely by a single entity and in the case of some investments solely by CS, or an associate of CS or CS may be the only market maker in such investments. Past performance should not be taken as an indication or guarantee of future performance, and no representation or warranty, express or implied, is made regarding future performance. Information, opinions and estimates contained in this report reflect a judgment at its original date of publication by CS and are subject to change without notice. The price, value of and income from any of the securities or financial instruments mentioned in this report can fall as well as rise. The value of securities and financial instruments is subject to exchange rate fluctuation that may have a positive or adverse effect on the price or income of such securities or financial instruments. Investors in securities such as ADRs, the values of which are influenced by currency volatility, effectively assume this risk. Structured securities are complex instruments, typically involve a high degree of risk and are intended for sale only to sophisticated investors who are capable of understanding and assuming the risks involved. The market value of any structured security may be affected by changes in economic, financial and political factors (including, but not limited to, spot and forward interest and exchange rates), time to maturity, market conditions and volatility, and the credit quality of any issuer or reference issuer. Any investor interested in purchasing a structured product should conduct their own investigation and analysis of the product and consult with their own professional advisers as to the risks involved in making such a purchase. Some investments discussed in this report may have a high level of volatility. High volatility investments may experience sudden and large falls in their value causing losses when that investment is realised. Those losses may equal your original investment. Indeed, in the case of some investments the potential losses may exceed the amount of initial investment and, in such circumstances, you may be required to pay more money to support those losses. Income yields from investments may fluctuate and, in consequence, initial capital paid to make the investment may be used as part of that income yield. Some investments may not be readily realisable and it may be difficult to sell or realise those investments, similarly it may prove difficult for you to obtain reliable information about the value, or risks, to which such an investment is exposed. This report may provide the addresses of, or contain hyperlinks to, websites. Except to the extent to which the report refers to website material of CS, CS has not reviewed any such site and takes no responsibility for the content contained therein. Such address or hyperlink (including addresses or hyperlinks to CS's own website material) is provided solely for your convenience and information and the content of any such website does not in any way form part of this document. Accessing such website or following such link through this report or CS's website shall be at your own risk.

This report is issued and distributed in **European Union (except Switzerland)**: by Credit Suisse Securities (Europe) Limited, One Cabot Square, London E14 4QJ, England, which is authorised by the Prudential Regulation Authority and regulated by the Financial Conduct Authority and the Prudential Regulation Authority. **Germany**: Credit Suisse Securities (Europe) Limited Niederlassung Frankfurt am Main regulated by the Bundesanstalt fuer Finanzdienstleistungsaufsicht ("BaFin"). **United States and Canada**: Credit Suisse Securities (USA) LLC; **Switzerland**: Credit Suisse AG; **Brazil**: Banco de Investimentos Credit Suisse (Brasil) S.A or its affiliates; **Mexico**: Banco Credit Suisse (México), S.A. (transactions related to the securities mentioned in this report will only be effected in compliance with applicable regulation); **Japan**: by Credit Suisse Securities (Japan) Limited, Financial Instruments Firm, Director-General of Kanto Local Finance Bureau ( *Kinsho*) No. 66, a member of Japan Securities Dealers Association, The Financial Futures Association of Japan, Japan Investment Advisers Association, Type II Financial Instruments Firms Association; **Hong Kong**: Credit Suisse (Hong Kong) Limited; **Australia**: Credit Suisse Equities (Australia) Limited; **Thailand**: Credit Suisse Securities (Thailand) Limited, regulated by the Office of the Securities and Exchange Commission, Thailand, having registered address at 990 Abdulrahim Place, 27th Floor, Unit 2701, Rama IV Road, Silom, Bangkok, Bangkok10500, Thailand, Tel. +66 2614 6000; **Malaysia**: Credit Suisse Securities (Malaysia) Sdn Bhd, Credit Suisse AG, Singapore Branch; **India**: Credit Suisse Securities (India) Private Limited (CIN no.U67120MH1996PTC104392) regulated by the Securities and Exchange Board of India as Research Analyst (registration no. INH 00001030) and as Stock Broker (registration no. INB230970637; INF230970637; INB010970631; INF010970631), having registered address at 9th Floor, Ceejay House, Dr.A.B. Road, Worli, Mumbai - 18, India, T. +91-22 6777 3777; **South Korea**: Credit Suisse Securities (Europe) Limited, Seoul Branch; **Taiwan**: Credit Suisse AG Taipei Securities Branch; **Indonesia**: PT Credit Suisse Securities Indonesia; **Philippines**: Credit Suisse Securities (Philippines) Inc., and elsewhere in the world by the relevant authorised affiliate of the above.

#### Additional Regional Disclaimers

**Hong Kong**: Credit Suisse (Hong Kong) Limited ("CSHK") is licensed and regulated by the Securities and Futures Commission of Hong Kong under the laws of Hong Kong, which differ from Australian laws. CSHKL does not hold an Australian financial services licence (AFSL) and is exempt from the requirement to hold an AFSL under the Corporations Act 2001 (the Act) under Class Order 03/1103 published by the ASIC in respect of financial services provided to Australian wholesale clients (within the meaning of section 761G of the Act). Research on Taiwanese securities produced by Credit Suisse AG, Taipei Securities Branch has been prepared by a registered Senior Business Person.

**Malaysia**: Research provided to residents of Malaysia is authorised by the Head of Research for Credit Suisse Securities (Malaysia) Sdn Bhd, to whom they should direct any queries on +603 2723 2020.

**Singapore**: This report has been prepared and issued for distribution in Singapore to institutional investors, accredited investors and expert investors (each as defined under the Financial Advisers Regulations) only, and is also distributed by Credit Suisse AG, Singapore branch to overseas investors (as defined under the Financial Advisers Regulations). By virtue of your status as an institutional investor, accredited investor, expert investor or overseas investor, Credit Suisse AG, Singapore branch is exempted from complying with certain compliance requirements under the Financial Advisers Act, Chapter 110 of Singapore (the "FAA"), the Financial Advisers Regulations and the relevant Notices and Guidelines issued thereunder, in respect of any financial advisory service which Credit Suisse AG, Singapore branch may provide to you.

**UAE**: This information is being distributed by Credit Suisse AG (DIFC Branch), duly licensed and regulated by the Dubai Financial Services Authority ("DFSA"). Related financial services or products are only made available to Professional Clients or Market Counterparties, as defined by the DFSA, and are not intended for any other persons. Credit Suisse AG (DIFC Branch) is located on Level 9 East, The Gate Building, DIFC, Dubai, United Arab Emirates.

**EU**: This report has been produced by subsidiaries and affiliates of Credit Suisse operating under its Global Markets Division

This research may not conform to Canadian disclosure requirements.

In jurisdictions where CS is not already registered or licensed to trade in securities, transactions will only be effected in accordance with applicable securities legislation, which will vary from jurisdiction to jurisdiction and may require that the trade be made in accordance with applicable exemptions from registration or licensing requirements. Non-US customers wishing to effect a transaction should contact a CS entity in their local jurisdiction unless governing law permits otherwise. US customers wishing to effect a transaction should do so only by contacting a representative at Credit Suisse Securities (USA) LLC in the US.

Please note that this research was originally prepared and issued by CS for distribution to their market professional and institutional investor customers. Recipients who are not market professional or institutional investor customers of CS should seek the advice of their independent financial advisor prior to taking any investment decision based on this report or for any necessary explanation of its contents. This research may relate to investments or services of a person outside of the UK or to other matters which are not authorised by the Prudential Regulation Authority and regulated by the Financial Conduct Authority and the Prudential Regulation Authority or in respect of which the protections of the Prudential Regulation Authority and Financial Conduct Authority for private customers and/or the UK compensation scheme may not be available, and further details as to where this may be the case are available upon request in respect of this report.

CS may provide various services to US municipal entities or obligated persons ("municipalities"), including suggesting individual transactions or trades and entering into such transactions. Any services CS provides to municipalities are not viewed as "advice" within the meaning of Section 975 of the Dodd-Frank Wall Street Reform and Consumer Protection Act. CS is providing any such services and related information solely on an arm's length basis and not as an advisor or fiduciary to the municipality. In connection with the provision of the any such services, there is no agreement, direct or indirect, between any municipality (including the officials, management, employees or agents thereof) and CS for CS to provide advice to the municipality. Municipalities should consult with their financial, accounting and legal advisors regarding any such services provided by CS. In addition, CS is not acting for direct or indirect compensation to solicit the municipality on behalf of an unaffiliated broker, dealer, municipal securities dealer, municipal advisor, or investment adviser for the purpose of obtaining or retaining an engagement by the municipality for or in connection with Municipal Financial Products, the issuance of municipal securities, or of an investment adviser to provide investment advisory services to or on behalf of the municipality. If this report is being distributed by a financial institution other than Credit Suisse AG, or its affiliates, that financial institution is solely responsible for distribution. Clients of that institution should contact that institution to effect a transaction in the securities mentioned in this report or require further information. This report does not constitute investment advice by Credit Suisse to the clients of the distributing financial institution, and neither Credit Suisse AG, its affiliates, and their respective officers, directors and employees accept any liability whatsoever for any direct or consequential loss arising from their use of this report or its content. Principal is not guaranteed. Commission is the commission rate or the amount agreed with a customer when setting up an account or at any time after that.

Copyright © 2016 CREDIT SUISSE AG and/or its affiliates. All rights reserved.

Investment principal on bonds can be eroded depending on sale price or market price. In addition, there are bonds on which investment principal can be eroded due to changes in redemption amounts. Care is required when investing in such instruments.

When you purchase non-listed Japanese fixed income securities (Japanese government bonds, Japanese municipal bonds, Japanese government guaranteed bonds, Japanese corporate bonds) from CS as a seller, you will be requested to pay the purchase price only.